

# centor ARCHITECTURAL

E2 folding door hardware system for panels to 60kg



# CONTENTS

Creating Seamless Transitions .....	1
Imagine The Possibilities .....	2
High Performance System .....	3
Proven Durability .....	4
E2 Up Close .....	5
E2 Assurance .....	6
Centor's Folding Options .....	7
E2 Product Details .....	8
Architectural Detail .....	9
Component Selection .....	12
Dropbolts .....	21
Door Size Calculator .....	28
Common Panel Layouts .....	29
Surelock™ Adjustment .....	32

While every effort has been made to ensure the accuracy of the information in this publication, Centor Architectural assume no responsibility for errors or omissions or any consequences of reliance solely on this publication.

# Creating Seamless Transitions

E2 is a folding door hardware system for individual door panels up to a maximum of 60 kilograms. Available in a range of finishes, E2 is the smart choice for matching hardware to a range of residential and light commercial applications which do not require the extra panel weight capacity of E3 or the substantial heavy door capacity of the E4 system. E2 offers all the space-creating benefits of the larger systems in a refined yet economical package.

TOP-HUNG FOLDING SYSTEM

16 DOOR PANEL CAPABILITY

60 KILOGRAM DOOR PANEL CAPACITY

STAINLESS STEEL COMPONENTS



Centor doesn't believe in changing for the sake of change. The evolution of the E2 system is a major advance in visually and physically connecting interiors and exteriors. The system that started the folding revolution, E2 still offers all the space-creating benefits of the larger E series systems in a refined 60kg package with a range of available finishes.

E2 Specifications	
max opening width	16000mm
max panel weight	60kg
max panel height	3000mm
max panel width	1100mm
min panel thickness	35mm
max number of panels	16 (8 each direction)

**Note:** Specifications are intended as a guide only. Calculated weight check should be performed to ensure doors built to maximum height and width do not exceed maximum weight.





## Imagine The Possibilities

Business or pleasure, E2 means entertainment without the interruption of conventional sliding or hinged doors, views which become vistas, a breeze when you please! Over the past decade Centor Architectural's ground-breaking exterior folding window and door technology has caused a worldwide revolution in window and door installation.



Both functional and stylish, Centor Architectural's folding door systems allow flexibility and ease when dividing or opening up space within residential or commercial applications. Centor folding systems can be used inside and out allowing views and rooms to be accessed at a moments notice.

The doors are able to be opened either inward or outward, with odd or even numbers of panels in any configuration, leaving no interruptions from posts or fixed glass panels. Designed to ensure an effective weatherproof barrier against the harshest conditions, Centor systems achieve superior rain and wind resistance, in part, from the way the door panels close snugly against rubber weather seals.

Centor's lifestyle changing, folding systems will allow any residence or business to flexibly manage interior and exterior space with any situation that may appear.

## CREATING SPACE



## High Performance System

Interior comfort, operational function, durability; painstaking attention to detail and an unerring commitment to quality combine for a 'Centor-grade' performance. The result is a degree of control and comfort for the end-user that matches the convenience of modern design.



### INTERIOR COMFORT

E2 is truly a system for all seasons and all locations. Teamed with quality door panels, E2 hardware ensures a formidable barrier against the elements when closed. The integrity of the required internal environment is never compromised.

#### Weatherproof

Impressive water performance ratings are achievable from both outward and inward opening doors with the system achieving its superior rain and wind resistance, in part from the way it allows door panels to close snugly against rubber weather seals. Centor hardware was utilised in the first tracked folding door system to be certified under Australian Standard AS2047, which specifies the weather performance required of external windows and sliding doors. Resistance to air infiltration is up to 50 times better than a sliding door and impressive acoustic sealing qualities are a resulting bonus, particularly when E2 is used indoors. A floating wall pivot is used to control door stile deflection caused by wind loads or climatic conditions.

#### Door Screen Compatible

E2 is fully compatible with the S1 Door Screen, Centor's superbly effective, world-first screening solution for large scale openings.

#### Indoor Applications

While originally designed as an effective weatherproof barrier against the natural elements, the E2 system is just as popular for creating stylish openings within interior spaces.

### EFFORTLESS OPERATION

While E2's outstanding performance as part of a secure, weatherproof barrier is crucial, it's not until the doors are opened that the space-transforming benefits of the system truly come into play. For maximum enjoyment and use of the system, every effort has been made to ensure that doors glide open and slide shut with minimum of effort throughout their working life.

#### Quality Manufacture, Innovative Design

E2 carriers, guides and pivots use high grade stainless steel bearings custom machined to extremely fine tolerances on state-of-the-art German and Swiss machinery – a minimum of three bearings to each carrier. Machined wheels are individually precision ground to an ultra-fine hone. Innovative carrier design prevents scraping on the inside of the overhead track. A polypropylene floor channel lining adds to the smooth, almost silent rolling action which brings delight to the face of the user!

#### Assembly and Installation

With quick-fix surface-mounted fittings, assembly and installation couldn't be easier. Comprehensive instructions are included.

#### Adjustment

While E2 is designed to operate flawlessly well into the future, built-in adjustment mechanisms make the system tolerant of an imperfect world. Surelock™, Centor's patented carrier pin locking system ensures that once heights are set they stay set, but should door panels swell or a newly built structure settle over time, vertical and lateral adjustments can simply be made by using a screwdriver.

### COLLABORATIVE DESIGN PROCESS

E2's thoughtful design doesn't achieve the highest performance in all categories on its own. It's in its element teamed with the quality products created by Centor's many manufacturing and custom fabricating clients. The Centor technical department can assist in the design process for door sets incorporating the E2 system to ensure that the highest criteria for completed and installed doors are met even in the most unusual applications.

## Proven Durability

While Centor Architectural certainly enjoys its reputation for innovation, ensuring that products meet and exceed the highest standards for durability is just as much a passion. This means a significant investment in repeatedly testing systems under the toughest of conditions – then testing them again!



Attention to detail in design, testing and manufacture creates 'Centor-grade' performance.



# CREATING LONGEVITY

### LABORATORY TESTING

In addition to extensive weather testing as part of complete door systems, all individual E2 components have been extensively laboratory tested, ensuring years of trouble-free enjoyment from the hardware.

#### Cyclic Testing

Centor's minimum requirement of cyclic testing for any released product is a grueling 50,000 cycles without a single failure at maximum configuration. E2 has been tested in excess of 50,000 cycles with many components rated to over 100,000 cycles.

#### Corrosion Testing

Stainless steel, aluminum and engineering-grade plastics are used throughout the E2 system and are carefully selected to maximise performance in any environment. Centor conducts regular, thorough corrosion testing in a salt spray chamber, fixing hardware to various substrates to ensure that E2 will perform consistently.

#### Structural Testing

Structural proof load tests up to 3600 Pa (74 psf) have been achieved. Structural results are highly dependant on the door panel area and height and the engineering properties of the door and frames.

#### Finite Element Analysis

Finite Element Analysis (FEA) is a computerised simulation technique where products are exposed to virtual operating environments and accurate predictions made in terms of load and deflection. Centor undertakes FEA in the design process to ensure the best balance of performance, value and materials in every system.

#### Hurricane Testing

In the course of obtaining approval under the stringent Miami-Dade County testing regime, doors based on the larger E4 system were subjected to hurricane strength wind loads, flexing the doors in and out five thousand times without component failure. Small and large missile impact testing was also performed as part of the single toughest testing process anywhere in the world.

Although not hurricane tested the E2 system is based on the same weather resistance principles as E4, while using lighter door panels to create an economical package.

# CREATING DELIGHT

## E2 Up Close

Even a casual glance at the E2 system gives a strong impression of Centor's commitment to quality, but it's only upon closer inspection that the attention to detail really becomes apparent. Stacked with standard features and with an abundance of options to choose from, Centor E2 looks even better up close!

### Materials and Finishes

E2 carriers, guides, pivots and hinges are available in brushed stainless steel for a modern industrial look, a PVD brass finish over stainless steel should a more traditional finish be required, or custom powdercoated in a range of colours. Head tracks are produced in extruded aluminium in satin natural or gold anodised finish. Floor guide channels and sills are produced in aluminium in various finishes with black polypropylene liner.

### Panel Size and Materials

Centor's innovative hinge system enables the use of uniform-sized door panels regardless of the door configuration ensuring maximum efficiency in door manufacture. Easily installed hardware can be teamed with door panels in timber, aluminium, PVC or fiberglass.

### Unobtrusive Guide Channel

Offset floor guides and floor pivots allow the floor guide channel to be concealed beneath closed doors. A range of ready-made door sills compatible with E2 simplify the installation of folding doors in exposed applications and ensure a stylish, seamless result.

### Dropbolts

Easily installed with a dedicated router bit available from Centor, DF, DH and DO dropbolts are available in a range of lengths and finishes to suit every E2 application. Available keyed and non-keyed, and for both inward and outward opening doors, the clean-lined DF, DH and DO dropbolts anchor doors firmly in the closed position and, together with the weather seals, eliminate rattling in strong winds.



> Centor's E2 Intermediate Carrier and Concealed Intermediate Guide.

Up close the attention to detail and commitment to quality are obvious.

### E2 Specifications

max opening width	16000m
max panel weight	60kg
max panel height	3000mm
max panel width	1100mm
min panel thickness	35mm
max number of panels	16 (8 each direction)

**Note:** Specifications are intended as a guide only. Calculated weight check should be performed to ensure doors built to maximum height and width do not exceed maximum weight.



## E2 Assurance

If success in modern design can be measured by the degree of comfort and ease afforded to the end-user, then Centor E2 again rates highly. E2's superior function and performance goes a long way to creating a relaxed setting while a range of other measures allow the system to be utilised with complete confidence.



### UNPARALLELED SECURITY

The E2 system responds to an increasingly security conscious market place with measures designed to ensure unwanted visitors are excluded - as well as the elements.

System design, system features and Centor dropbolts combine as an effective security barrier in all door configurations.

### HARDWARE SELECTION

E2 is a fully integrated system suitable for applications up to 40 Kg per panel in timber, aluminium, PVC or fiberglass. Architects and specifiers should feel comfortable simply specifying 'Centor E2' and leaving detailed component selection to the builder, joiner or fabricator.

### DOOR SCREEN COMPATIBLE

E2 is fully compatible with the S1 Door Screen, Centor's superbly effective, world-first screening solution for large scale openings.

### WARRANTY

In line with a commitment to the highest possible quality Centor offers a 10-year warranty on all E2 hardware.

For full details view information on line at [www.centor.eu](http://www.centor.eu)





# 4 CREATING CHOICE

## Centor's Folding Options

Based on the same functional geometry but with distinctive capacity and features, Centor's external folding range offers an alternative for every application. From the smallest folding window to four metre high walls of glass which fold away in seconds, Centor folding systems create a formidable barrier against the elements, yet glide open with finger-tip ease.

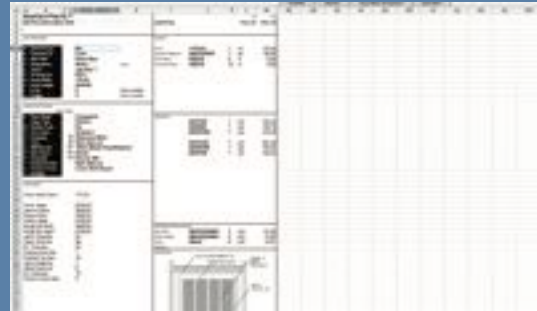

### Free Specification And Ordering Software

Doorcalc, Centor's free specification and ordering software simplifies component selection and assists with calculating size and number of door panels.

Doorcalc can be downloaded from [www.centor.eu](http://www.centor.eu)

It features intuitive drop-down menus to assist the inexperienced Excel® user.

## CREATING CONFIDENCE

Developed first and constantly upgraded since their inception EW and E2 remain the perfect choice for the private residence or lighter commercial application. E3 and E4 are Centor's responses to the demands of architects and consumers wishing to expand the potential of folding innovation into heavier-duty residential and commercial applications. The medium-heavy E3 doubles the panel weight capacity of the E2 system, making even sturdier panel materials and double glazing possible. The heavy-duty E4 system takes it even further. A massive panel weight capacity (120kg) and substantially increased height, width and overall measurement specifications ensures that Centor folding systems remain the perfect choice for virtually every project.



## E2 Product Details

### DOWNLOADABLE CAD FILES

DXF or DWG files ready for use in your own documentation are a convenient resource for architects and specifiers wishing to use Centor systems.

E2 DXF or DWG files can be downloaded from [www.centor.eu](http://www.centor.eu)

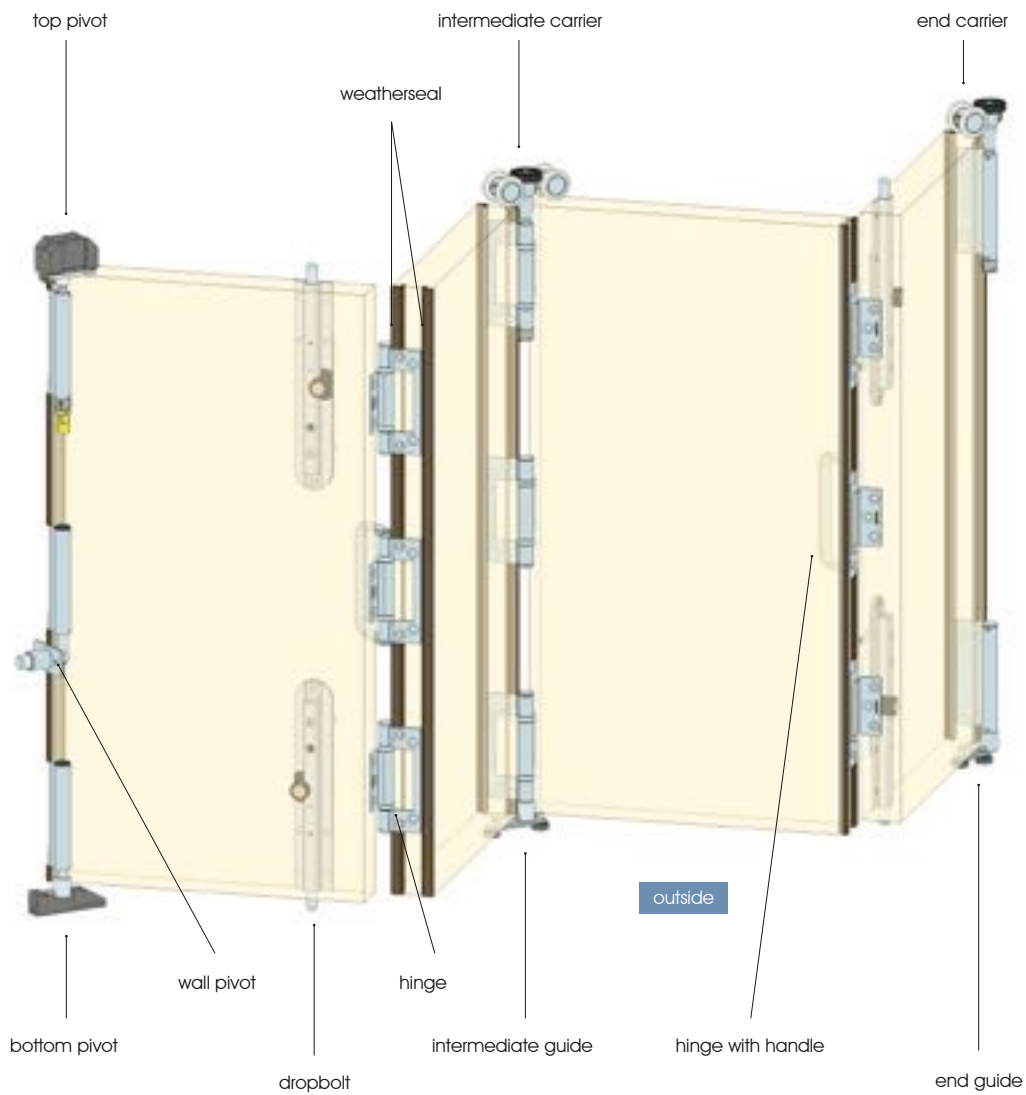

# Architectural Detail

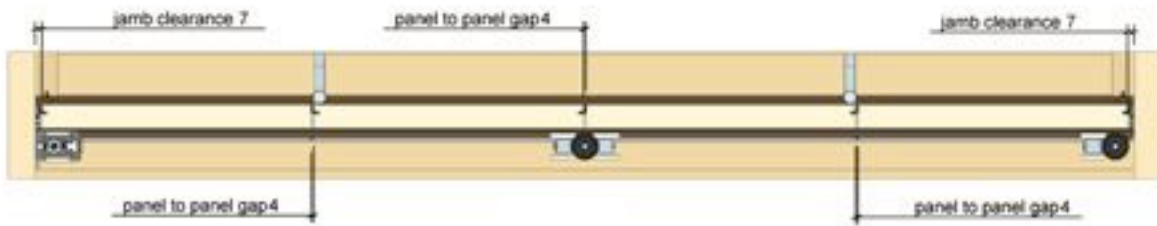

E2-001.DXF

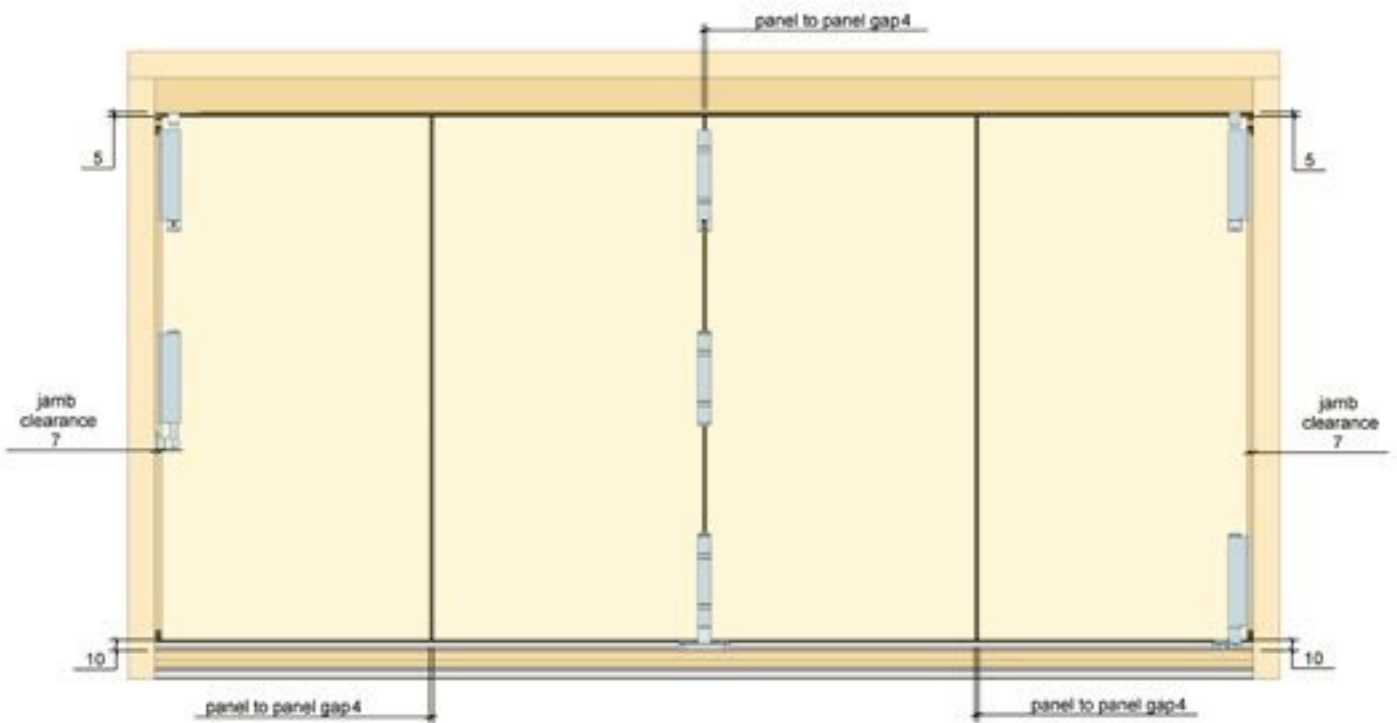

E2-002.DXF

# Architectural Detail

## CONCEALED GUIDE

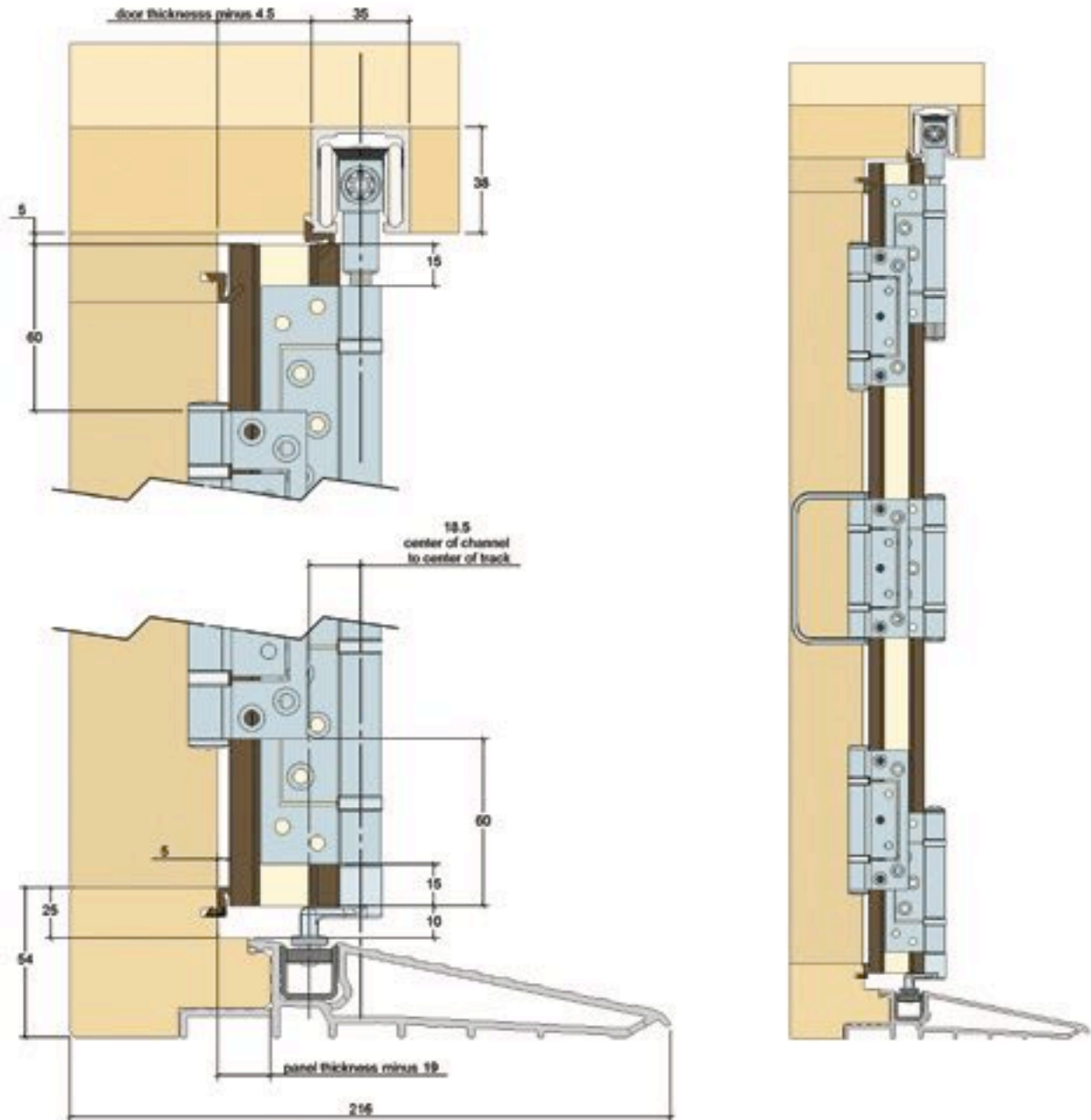

AQ21 recommended for end panels and frame seals

AQ63 recommended for inter-panel seals

AQ109 recommended for swing connecting panels

E2-200.DXF

# Architectural Detail

## CONCEALED GUIDE WITH TIMBER SILL

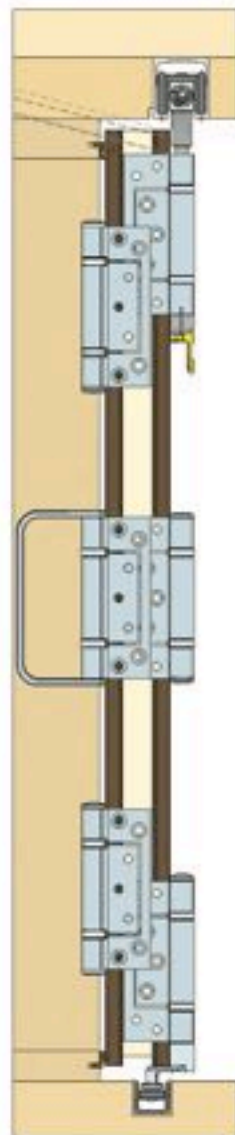
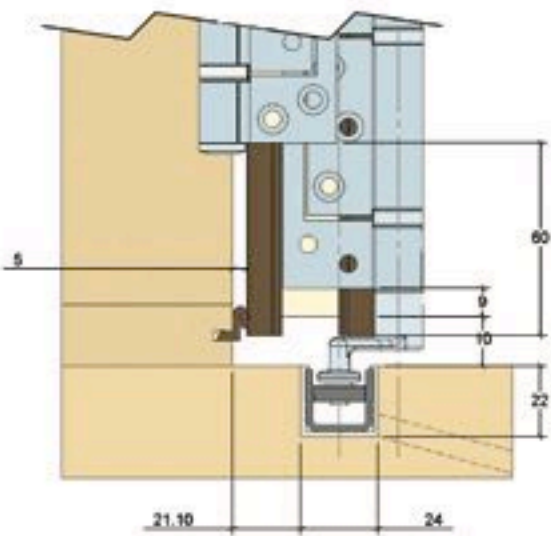
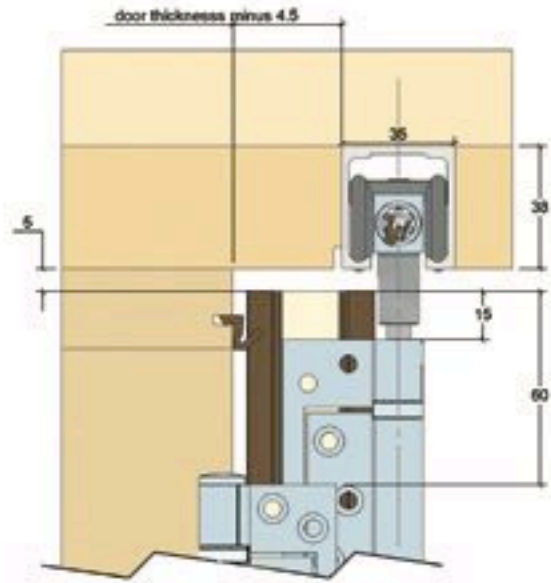

AQ21 recommended for end panels and frame seals  
AQ63 recommended for inter-panel seals  
AQ109 recommended for swing connecting panels

E2-201.DXF

## Component Selection

E2 is specified with 5 separate component groups. Components are required from each group to build an E2 folding door system.

- 1 **Track** – choose surface finish and size required to suit opening
- 2 **Sill Assembly** – choose either Centor sill or floor channel and size, to suit application
- 3 **Door Hardware Sets** – choose surface finish and sets required to suit panel layout
- 4 **Dropbolts** – choose surface finish, type, size & number required to suit panel layout
- 5 **Weather Seals** – choose colour, type and amount of each seal required to suit opening size and panel layout

### TRACK

PART	TRACK	PRODUCT CODE	DESCRIPTION
	aluminium track, machined	14TAM1730N	1730mm machined track, natural anodised
		14TAM2030N	2030mm machined track, natural anodised
		14TAM2330N	2330mm machined track, natural anodised
		14TAM2930N	2930mm machined track, natural anodised
		14TAM3530N	3530mm machined track, natural anodised
		14TAM4N	4000mm machined track, natural anodised
		14TAM4130N	4130mm machined track, natural anodised
		14TAM6N	6000mm machined track, natural anodised
		14TAM24G	2330mm machined track, gold anodised
		14TAM30G	2930mm machined track, gold anodised
		14TAM4G	4000mm machined track, gold anodised
		14TAM6G	6000mm machined track, gold anodised



## Component Selection

### UNDERDOOR GUIDE CHANNELS

PART	CHANNEL	PRODUCT CODE	DESCRIPTION
	concealed channel 24mm, retainer	E22FCR24N	2400mm floor channel retainer, natural anodised
		E22FCR3N	3000mm floor channel retainer, natural anodised
		E22FCR36N	3600mm floor channel retainer, natural anodised
		E22FCR4N	4000mm floor channel retainer, natural anodised
		E22FCR6N	6000mm floor channel retainer, natural anodised
		E22FCR24G	2400mm floor channel retainer, gold anodised
		E22FCR3G	3000mm floor channel retainer, gold anodised
		E22FCR36G	3600mm floor channel retainer, gold anodised
		E22FCR4G	4000mm floor channel retainer, gold anodised
		E22FCR6G	6000mm floor channel retainer, gold anodised
		E22FCR4R	4000mm floor channel retainer, bronze
E22FCR6R	6000mm floor channel retainer, bronze		
	concealed channel 21mm, poly channel	E22FCP24	2400mm floor channel, polypropylene
		E22FCP30	3000mm floor channel, polypropylene
		E22FCP36	3600mm floor channel, polypropylene
		E22FCP4	4000mm floor channel, polypropylene
		E22FCP42	4130mm floor channel, polypropylene
		E22FCP6	6000mm floor channel, polypropylene

# Component Selection

## OUTWARD CONCEALED SILL

PARTS	PRODUCT CODE	DESCRIPTION
	E3CDSM36N	3600mm concealed sill, machined, natural anodised
	E3CDSM42N	4200mm concealed sill, machined, natural anodised
	E3CDSM57N	5700mm concealed sill, machined, natural anodised
	E3CDSM36R	3600mm concealed sill, machined, bronze anodised
	E3CDSM42R	4200mm concealed sill, machined, bronze anodised
	E3CDSM57R	5700mm concealed sill, machined, bronze anodised
	E3CDSECL	end cap left
	E3CDSECR	end cap right

## CONCEALED SELF DRAINING SILL FOR OUTWARD OPENING DOORS

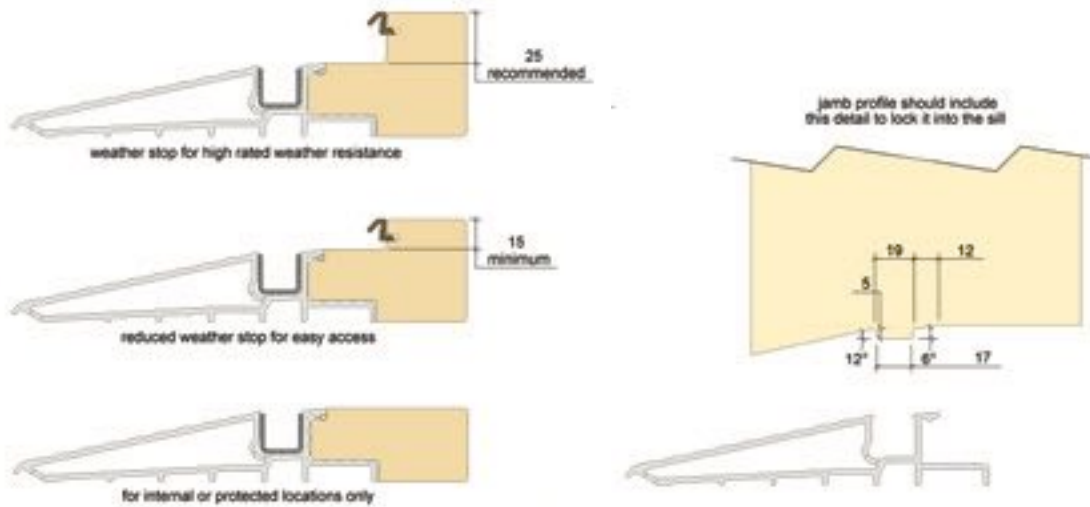

## END CAP

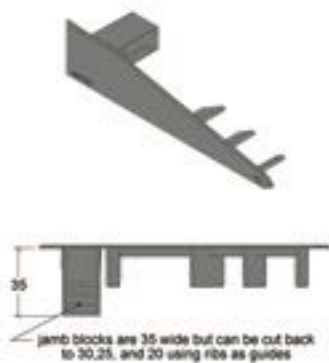



## Component Selection

### LEFT CARRIER SET – CONCEALED GUIDE

PART	PRODUCT CODE	DESCRIPTION
	E2CLCSS	concealed left hand carrier set, stainless steel
	E2CLCSTG	concealed left hand carrier set, PVD brass

### RIGHT CARRIER SET – CONCEALED GUIDE

PART	PRODUCT CODE	DESCRIPTION
	E2CRCSS	concealed right hand carrier set, stainless steel
	E2CRCSTG	concealed right hand carrier set, PVD brass

### MEETING CARRIER SET – CONCEALED GUIDE

PART	PRODUCT CODE	DESCRIPTION
	E2CMCSS	concealed meeting carrier set, stainless steel
	E2CMCSTG	concealed meeting carrier set, PVD brass

## Component Selection

### INTERMEDIATE CARRIER SETS – CONCEALED GUIDE

PART	PRODUCT CODE	DESCRIPTION
Fast-fix 	E2CICSS	concealed intermediate carrier set, stainless steel
	E2CICSTG	concealed intermediate carrier set, PVD brass

### WALL PIVOT SETS

PART	PRODUCT CODE	DESCRIPTION
	E22WPSS	wall pivot set, stainless steel
	E22WPSTG	wall pivot set, PVD brass

### PIVOT SET – CONCEALED GUIDE

PART	PRODUCT CODE	DESCRIPTION
	E2CPSS	concealed pivot set, stainless steel
	E2CPSTG	concealed pivot set, PVD brass

## Component Selection



### PIVOT SET – WALL MOUNTED LOWER PIVOT

Suitable for internal door and window applications only

PART	PRODUCT CODE	DESCRIPTION
	E2BPPSS	pivot set, stainless steel
	E2BPICSS	intermediate carrier set, stainless steel
	E2BPECSS	end carrier set, stainless steel

## Component Selection

### HINGE SETS – FAST-FIX

PART	PRODUCT CODE	DESCRIPTION
with handle 	E22HSS	hinge set, stainless steel
	E22HSTG	hinge set, PVD brass
without handle 	E22HNHSS	no handle hinge set, stainless steel
	E22HNHSTG	no handle hinge set, PVD brass

### SINGLE HINGE (FOURTH HINGE RECOMMENDED FOR HIGH DOORS)



PART	PRODUCT CODE	DESCRIPTION
	E22HHNHS	single straight hinge, stainless steel
	E22HHNHTG	single straight hinge, PVD brass

### SINGLE HINGE WITH HANDLE (FOURTH HINGE WITH HANDLE RECOMMENDED FOR HIGH DOORS)

PART	PRODUCT CODE	DESCRIPTION
	E22HHS	single straight hinge with handle, stainless steel
	E22HHTG	single straight hinge with handle, PVD brass

## Component Selection

### HALF OFFSET HINGE SETS – FAST-FIX

PART	PRODUCT CODE	DESCRIPTION
with handle 	E22HHSS	half offset hinge set, stainless steel
	E22HHSTG	half offset hinge set, PVD brass
without handle 	E22HHNHSS	no handle half offset hinge set, stainless steel
	E22HHNHSTG	no handle half offset hinge set, PVD brass

### SINGLE HALF OFFSET HINGE (FOURTH HINGE RECOMMENDED FOR HIGH DOORS)

PART	PRODUCT CODE	DESCRIPTION
	E22HHNHS	single half offset hinge, stainless steel
	E22HHNHTG	single half offset hinge, PVD brass

### SINGLE HALF OFFSET HINGE WITH HANDLE (FOURTH HINGE WITH HANDLE RECOMMENDED FOR HIGH DOORS)



PART	PRODUCT CODE	DESCRIPTION
	E22HHS	single half offset hinge with handle, stainless steel
	E22HHTG	single half offset hinge with handle, PVD brass

## Component Selection

### EXTERNAL HANDLES

PART	PRODUCT CODE	DESCRIPTION
	E22EHS	external handle, stainless steel
	E22EHTG	external handle, PVD brass

### INTERNAL HANDLE

PART	PARTS ON PANELS	PRODUCT CODE	DESCRIPTION
		DF1IPHS	internal pull handle, stainless steel
		DF1IPTG	internal pull handle, gold anodised

### MAGNET PACK

PART	PRODUCT CODE	DESCRIPTION
	EWMP	magnet pack

## Dropbolts

Centor's stylish, flush-mounting dropbolts have been specifically designed for use with Centor systems and to meet the unique security and weatherproofing conditions that exist with folding doors. Easily installed with a dedicated router bit available from Centor, DF, DS and DO dropbolts are available in a range of lengths and finishes to suit every application. Available keyed and non-keyed, DF, DS and DO dropbolts are keyed alike or can be re-keyed.



### CENTOR DF

Rated to resist the most extreme wind conditions (up to 450kg in certain timbers) DF dropbolts feature rounded styling and are suited to use with outward opening folding doors. Available in 200mm, 400mm, 600mm and 1000mm lengths with a 20mm throw they come in gold anodised, brushed metallic, oil rubbed bronze and custom powdercoated finishes. Keyed DF dropbolts feature a unique folding damage-proofing mechanism which prevents the bolt being operated while the key remains in the lock.

### CENTOR DO

Offering all the style, security and choice of DF, DO dropbolts suit inward opening doors based on the E3 Concealed system. DO is installed at the top of the door panel while DO Concealed locks into the floor channel of the bifold system, meaning no extra holes or slots to drill or machine in the floor surface or door-sill. DO comes in gold anodised, brushed metallic and oil rubbed bronze powdercoat finishes.

### CENTOR DS

The 300mm length of the DS Dropbolt makes it an ideal bolt to install in tall windows, or in windows where furniture such as benches restrict accessibility. The slim profile of the DS makes it ideal for timber windows with narrow framing. The cylinder can be re-keyed to other window locks in the house by a professional locksmith.

### CENTOR DM

Half the length (100mm) of the smallest door dropbolt system and correspondingly narrow, Centor DM is designed to flush-mount into window frames with minimal visual impact. DM Dropbolt is suitable for locking casement, awning, sliding and bifold windows. DM can be supplied keyed alike to your DF or DH locks and can be re-keyed to other window locks in the house by any professional locksmith.

## Dropbolts (for outward opening doors)

### DF / KEYED

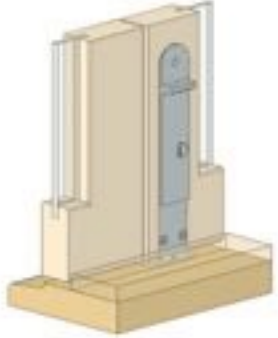
PARTS	ARCHITECTURAL DETAIL	PRODUCT CODE	DESCRIPTION
		DBFO200KRG	200mm dropbolt, keyed, gold anodised
		DBFO400KRG	400mm dropbolt, keyed, gold anodised
		DBFO600KRG	600mm dropbolt, keyed, gold anodised
		DBFO200KRX	200mm dropbolt, keyed, brushed metallic
		DBFO400KRX	400mm dropbolt, keyed, brushed metallic
		DBFO600KRX	600mm dropbolt, keyed, brushed metallic
		DBFO1000KRX	1000mm dropbolt, keyed, brushed metallic

### DF / NON-KEYED

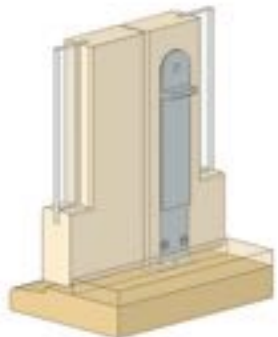
PARTS	ARCHITECTURAL DETAIL	PRODUCT CODE	DESCRIPTION
		DBFO200NRG	200mm dropbolt, non-keyed, gold anodised
		DBFO400NRG	400mm dropbolt, non-keyed, gold anodised
		DBFO600NRG	600mm dropbolt, non-keyed, gold anodised
		DBFO200NRX	200mm dropbolt, non-keyed, brushed metallic
		DBFO400NRX	400mm dropbolt, non-keyed, brushed metallic
		DBFO600NRX	600mm dropbolt, non-keyed, brushed metallic
		DBFO1000NRX	1000mm dropbolt, non-keyed, brushed metallic

### INSTALLATION

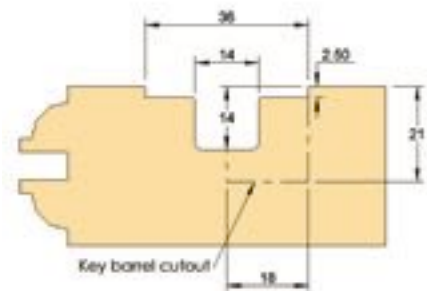



## Dropbolts (for outward opening doors)

### ROUTER BIT

PART	PRODUCT CODE	DESCRIPTION
	DBFORB	dedicated router bit for professional installation of Centor Architectural DH, DF, DL, DY and DO dropbolts

### DF CUPS

PART	PRODUCT CODE	DESCRIPTION
	DBCS	dropbolt cup, stainless steel
	DBCTG	dropbolt cup, brass

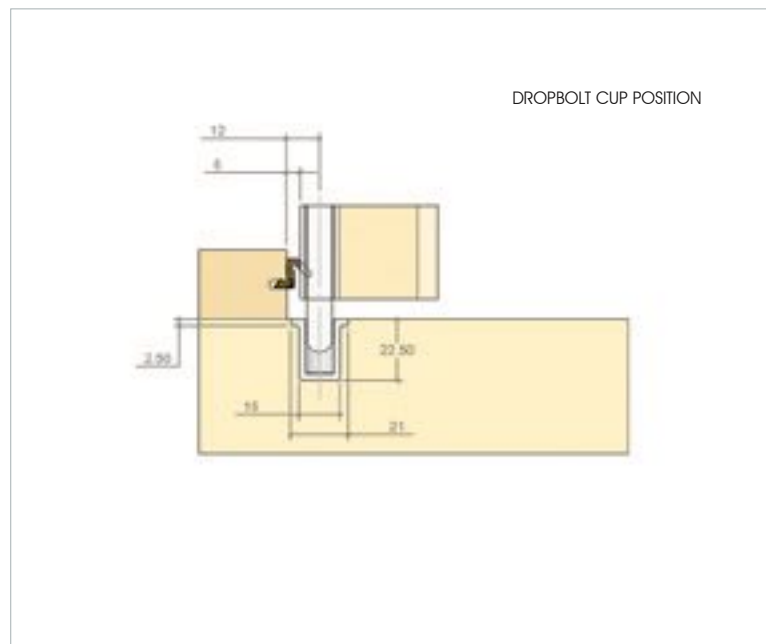

## Dropbolts (for outward opening windows)

### DM / KEYED

PARTS	PRODUCT CODE	DESCRIPTION
	DBMI100KRG	100mm dropbolt, keyed, gold anodised
	DBMI100NRX	100mm dropbolt, keyed, brushed metallic

### DM / NON-KEYED

PARTS	PRODUCT CODE	DESCRIPTION
	DBMI100NRG	100mm dropbolt, non-keyed, gold anodised
	DBMI100KRX	100mm dropbolt, non-keyed, brushed metallic

### DS / KEYED

PARTS	PRODUCT CODE	DESCRIPTION
	DBSO300KRG	300mm dropbolt, keyed, gold anodised
	DBSO300KRX	300mm dropbolt, keyed, brushed metallic

# Dropbolts (for outward opening windows)

## ROUTER BIT

PART	PRODUCT CODE	DESCRIPTION
	DBMIRB	dedicated router bit for installation of Centor Architectural DM and DS dropbolts

## CUPS

PART	PRODUCT CODE	DESCRIPTION
	DBMICL	moulded plastic cup

## INSTALLATION

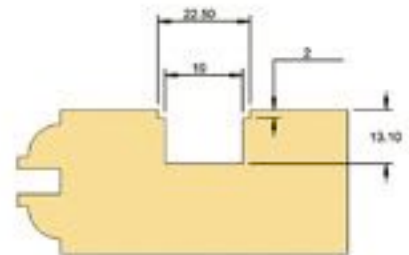

SO-002.DXF

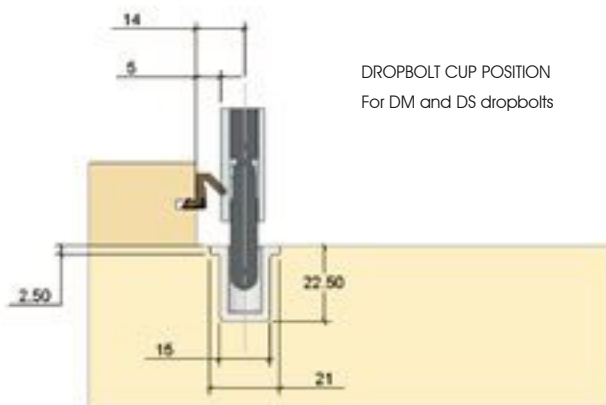

## Dropbolts (for inward opening doors)

### DOe / KEYED (TOP OF DOORS)

PARTS	PRODUCT CODE	DESCRIPTION
	DBOE200KRG	200mm, keyed, gold anodised
	DBOE400KRG	400mm, keyed, gold anodised
	DBOE600KRG	600mm, keyed, gold anodised
	DBOE200KRX	200mm, keyed, brushed metallic
	DBOE400KRX	400mm, keyed, brushed metallic
	DBOE600KRX	600mm, keyed, brushed metallic

### DOe / NON-KEYED (TOP OF DOORS)

PARTS	PRODUCT CODE	DESCRIPTION
	DBOE200NRG	200mm, non-keyed, gold anodised
	DBOE400NRG	400mm, non-keyed, gold anodised
	DBOE600NRG	600mm, non-keyed, gold anodised
	DBOE200NRX	200mm, non-keyed, brushed metallic
	DBOE400NRX	400mm, non-keyed, brushed metallic
	DBOE600NRX	600mm, non-keyed, brushed metallic
	DBOE1000NRX	1000mm, non-keyed, brushed metallic

INSTALLATION

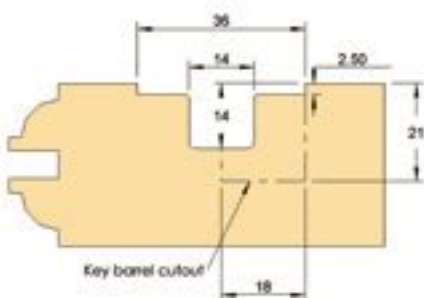

DROPBOLT CUP POSITION

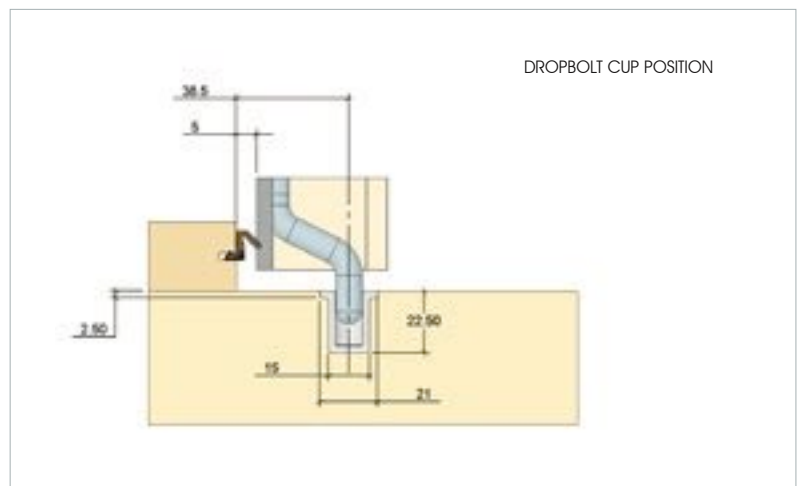

## Dropbolts (for inward opening doors)

DOc / KEYED (BOTTOM OF DOORS, FOR CONCEALED FLOOR CHANNEL)

PARTS	PRODUCT CODE	DESCRIPTION
	DBOC200KRG	200mm, concealed, keyed, gold anodised
	DBOC200KRX	200mm, concealed, keyed, brushed metallic

DOc / NON-KEYED (BOTTOM OF DOORS, FOR CONCEALED FLOOR CHANNEL)

PARTS	PRODUCT CODE	DESCRIPTION
	DBOC200NRG	200mm, concealed, non-keyed, gold anodised
	DBOC400NRG	400mm, concealed, non-keyed, gold anodised
	DBOC600NRG	600mm, concealed, non-keyed, gold anodised
	DBOC200NRX	200mm, concealed, non-keyed, brushed metallic
	DBOC400NRX	400mm, concealed, non-keyed, brushed metallic
	DBOC600NRX	600mm, concealed, non-keyed, brushed metallic
	DBOC1000NRX	1000mm, concealed, non-keyed, brushed metallic

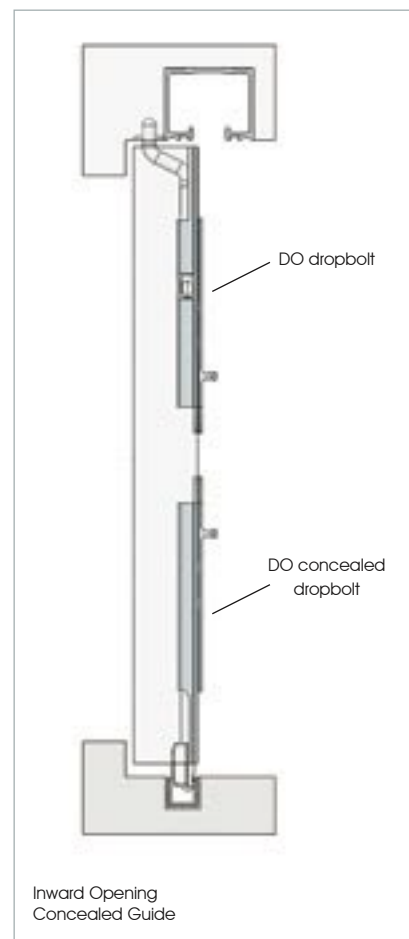
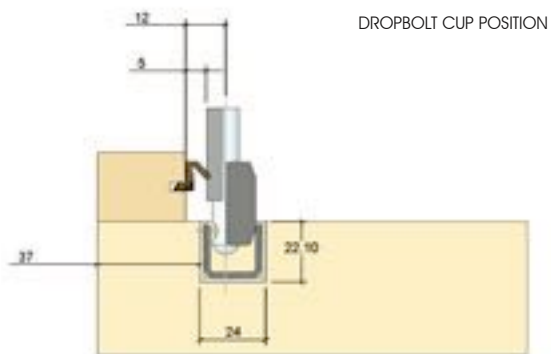

## Door Size Calculator

To calculate the dimensions of the doors or openings we strongly recommend using Centor's "Doorcalc" program, which is a Microsoft Excel spreadsheet (available at [www.centor.eu](http://www.centor.eu)). To manually calculate door sizing for an opening, follow the following steps:

- 1 Prepare a basic sketch of your door opening (see worked example), to visualize clearances and check sizes.
- 2 The calculation is based on all panels being equal width, using half-offset hinges. Note that the allowance between each panel is 4mm although hinge thickness is less – this allowance has been determined by consultation with fabricators as the best approximation for calculation. Clearance between hinges and hinge pins, coupled with the pressure from compression seals accounts for the allowance being larger than the nominal hinge flap thickness.

- 3 Recommended clearances are as follows;

- Jamb to panel (door closed) 7 mm
- Panel to panel (door closed) 4 mm
- Top of panel to head 5 mm
- Bottom of panel to sill 10mm

- 4 Panel width W  
Opening width L  
Total number of panels N  
Panel width is: 
$$\frac{W = L - 10 - (4 \times N)}{N}$$

### WORKED EXAMPLES

Clear opening size 2425 high x 4200 wide (L), and a 3L x 2R arrangement.

$$\frac{W = 4200 - 10 - (4 \times 5)}{5}$$

$$W = 834\text{mm}$$

Check against your door layout:

$$L = 2(7) + 4(4) + 5(834) = 4200 \text{ (OK)}$$

The panel height is the opening height less the nominal top and bottom clearances:

$$\text{Panel Height } H = 2425 - 5 - 10 = 2410\text{mm}$$

Note: Special amendments should be made for thick panels, narrow panels, even number configurations, and doors likely to expand by more than 1mm per panel.

# Common Panel Layouts

HARDWARE LEGEND	
<b>PS</b> pivot set	<b>RCS</b> right carrier set
<b>WPS</b> wall pivot set	<b>HHS</b> half offset hinge set
<b>ICS</b> intermediate carrier set	<b>HS</b> hinge set (straight)
<b>LCS</b> left carrier set	<b>DB</b> dropbolt
<b>IPH</b> internal pull handle	<b>EH</b> external handle

LEGEND	
Passage set / Lock by other	
Dropbolts top and bottom	

> Note Wall Pivot Set recommended for doors over 2250mm in height.

## HARDWARE APPLICATION (3L2R)

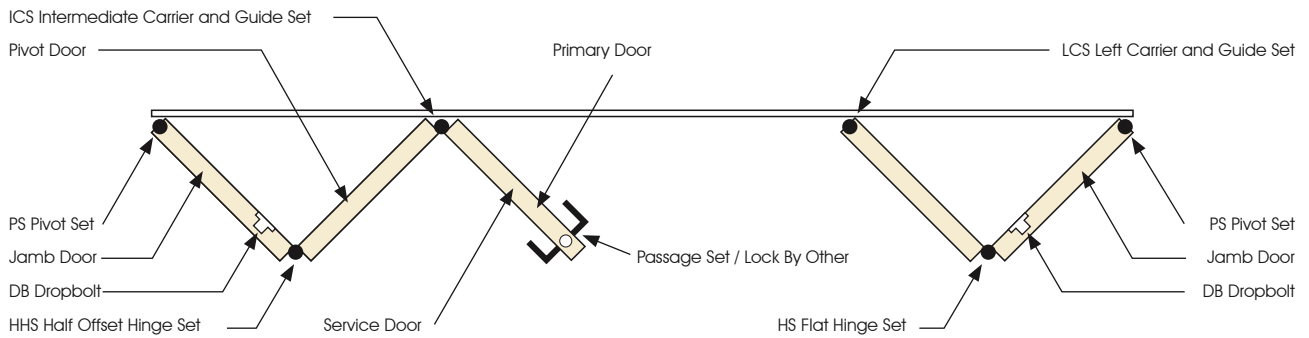

## OUTWARD APPLICATION EXTERIOR HANDLE OPTION

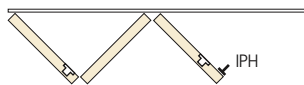

Use one interior pull handle on exit door (outswing system) where passage set / lock not required. Use dropbolts top and bottom to lock door from the inside only.

> Note Exit door not accessible from exterior in this application.

## INWARD APPLICATION EXTERIOR HANDLE OPTION

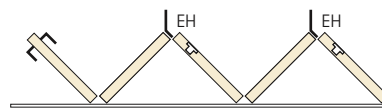

Use one exterior handle on each pair of doors (inswing system) to pull open and close doors

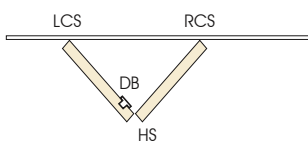

## TWO FLOATING DOOR

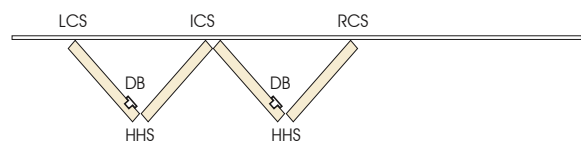

## FOUR FLOATING DOOR

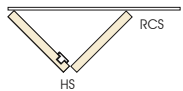
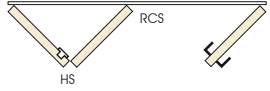
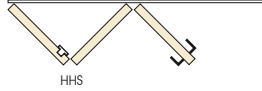
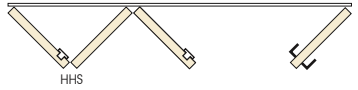
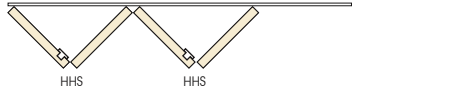
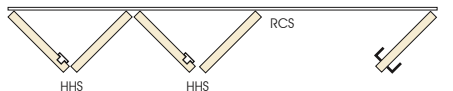
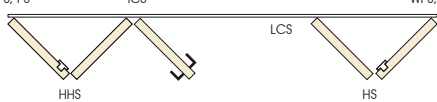
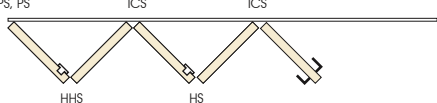
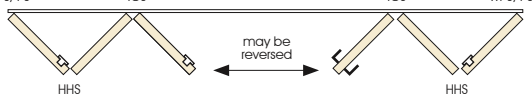
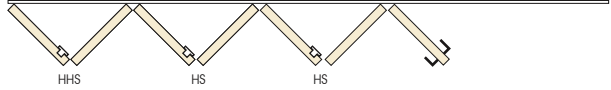

# Common Panel Layouts (outward)

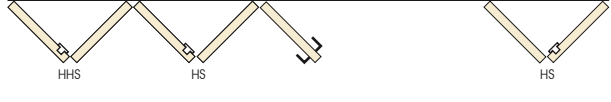
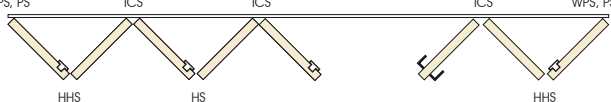
CODE	OPENING CONFIGURATION	HARDWARE
2L	<p>inside WPS, PS not accessible from exterior</p> <p>outside </p>	<p>1 x pivot set 1 x wall pivot set* 1 x right carrier set 1 x hinge set 2 x dropbolt</p>
2L1R	<p>inside WPS, PS WPS, PS</p> <p>outside </p>	<p>2 x pivot set 2 x wall pivot set* 1 x right carrier set 1 x hinge set 2 x dropbolt</p>
3L	<p>inside WPS, PS ICS</p> <p>outside </p>	<p>1 x pivot set 1 x wall pivot set* 1 x intermediate carrier set 1 x half offset hinge set 2 x dropbolt</p>
3L1R	<p>inside WPS, PS ICS WPS, PS</p> <p>outside </p>	<p>2 x pivot set 2 x wall pivot set* 1 x intermediate carrier set 1 x half offset hinge set 4 x dropbolt</p>
4L	<p>inside WPS, PS ICS RCS not accessible from exterior</p> <p>outside </p>	<p>1 x pivot set 1 x wall pivot set* 1 x intermediate carrier set 1 x right carrier set 2 x half offset hinge set 4 x dropbolt</p>
4L1R	<p>inside WPS, PS ICS WPS, PS</p> <p>outside </p>	<p>2 x pivot set 2 x wall pivot set* 1 x intermediate carrier set 1 x right carrier set 2 x half offset hinge set 4 x dropbolt</p>
3L2R	<p>inside WPS, PS ICS WPS, PS</p> <p>outside </p>	<p>2 x pivot set 2 x wall pivot set* 1 x intermediate carrier set 1 x left carrier set 1 x hinge set 1 x half offset hinge set 4 x dropbolt</p>
5L	<p>inside WPS, PS ICS ICS</p> <p>outside </p>	<p>1 x pivot set 1 x wall pivot set* 2 x intermediate carrier set 1 x hinge set 1 x half offset hinge set 4 x dropbolt</p>
3L3R	<p>inside WPS, PS ICS ICS WPS, PS</p> <p>outside </p>	<p>2 x pivot set 2 x wall pivot set* 2 x intermediate carrier set 2 x half offset hinge set 6 x dropbolt</p>
7L	<p>inside WPS, PS ICS ICS ICS</p> <p>outside </p>	<p>1 x pivot set 1 x wall pivot set* 3 x intermediate carrier set 2 x hinge set 1 x half offset hinge set 6 x dropbolt</p>
4L3R	<p>inside WPS, PS ICS RCS ICS WPS, PS</p> <p>outside </p>	<p>2 x pivot set 2 x wall pivot set* 2 x intermediate carrier set 1 x right carrier set 3 x half offset hinge set 6 x dropbolt</p>
5L2R	<p>inside WPS, PS ICS ICS WPS, PS</p> <p>outside </p>	<p>2 x pivot set 2 x wall pivot set* 2 x intermediate carrier set 1 x left carrier set 2 x hinge set 1 x half offset hinge set 6 x dropbolt</p>
5L3R	<p>inside WPS, PS ICS ICS ICS WPS, PS</p> <p>outside </p>	<p>2 x pivot set 2 x wall pivot set* 3 x intermediate carrier set 1 x hinge set 2 x half offset hinge set 8 x dropbolt</p>

\* Wall Pivot Sets required for doors over 2150mm. Recommended for panels over 1500mm.



# Common Panel Layouts (outward)

CODE	OPENING CONFIGURATION	HARDWARE
2R	<p>inside PS, WPS not accessible from exterior</p> <p>outside LCS HS</p>	<ul style="list-style-type: none"> <li>1 x pivot set</li> <li>1 x wall pivot set*</li> <li>1 x left carrier set</li> <li>1 x hinge set</li> <li>2 x dropbolt</li> </ul>
1L2R	<p>inside WPS, PS WPS, PS</p> <p>outside LCS HS</p>	<ul style="list-style-type: none"> <li>2 x pivot set</li> <li>2 x wall pivot set*</li> <li>1 x left carrier set</li> <li>1 x hinge set</li> <li>2 x dropbolt</li> </ul>
3R	<p>inside ICS WPS, PS</p> <p>outside HHS</p>	<ul style="list-style-type: none"> <li>1 x pivot set</li> <li>1 x wall pivot set*</li> <li>1 x intermediate carrier set</li> <li>1 x half offset hinge set</li> <li>2 x dropbolt</li> </ul>
1L3R	<p>inside WPS, PS ICS WPS, PS</p> <p>outside HHS</p>	<ul style="list-style-type: none"> <li>2 x pivot set</li> <li>2 x wall pivot set*</li> <li>1 x intermediate carrier set</li> <li>1 x half offset hinge set</li> <li>4 x dropbolt</li> </ul>
2L2R	<p>inside WPS, PS RCS LCS WPS, PS not accessible from exterior</p> <p>outside HS HS</p>	<ul style="list-style-type: none"> <li>2 x pivot set</li> <li>2 x wall pivot set*</li> <li>1 x right carrier set</li> <li>1 x left carrier set</li> <li>2 x hinge set</li> <li>4 x dropbolt</li> </ul>
1L4R	<p>inside WPS, PS LCS ICS WPS, PS</p> <p>outside HHS HHS</p>	<ul style="list-style-type: none"> <li>2 x pivot set</li> <li>2 x wall pivot set*</li> <li>1 x intermediate carrier set</li> <li>1 x left carrier set</li> <li>2 x half offset hinge set</li> <li>4 x dropbolt</li> </ul>
4R	<p>inside LCS ICS WPS, PS not accessible from exterior</p> <p>outside HHS HHS</p>	<ul style="list-style-type: none"> <li>1 x pivot set</li> <li>1 x wall pivot set*</li> <li>1 x intermediate carrier set</li> <li>1 x left carrier set</li> <li>2 x half offset hinge set</li> <li>4 x dropbolt</li> </ul>
2L3R	<p>inside WPS, PS RCS ICS WPS, PS</p> <p>outside HS HHS</p>	<ul style="list-style-type: none"> <li>2 x pivot set</li> <li>2 x wall pivot set*</li> <li>1 x intermediate carrier set</li> <li>1 x right carrier set</li> <li>1 x hinge set</li> <li>1 x half offset hinge set</li> <li>4 x dropbolt</li> </ul>
5R	<p>inside ICS ICS WPS, PS</p> <p>outside HS HHS</p>	<ul style="list-style-type: none"> <li>1 x pivot set</li> <li>1 x wall pivot set*</li> <li>2 x intermediate carrier set</li> <li>1 x hinge set</li> <li>1 x half offset hinge set</li> <li>4 x dropbolt</li> </ul>
3L4R	<p>inside WPS, PS ICS LCS ICS WPS, PS</p> <p>outside HHS HHS HHS</p>	<ul style="list-style-type: none"> <li>2 x pivot set</li> <li>2 x wall pivot set*</li> <li>2 x intermediate carrier set</li> <li>1 x left carrier set</li> <li>3 x half offset hinge set</li> <li>6 x dropbolt</li> </ul>
7R	<p>inside ICS ICS ICS WPS, PS</p> <p>outside HS HS HHS</p>	<ul style="list-style-type: none"> <li>1 x pivot set</li> <li>1 x wall pivot set*</li> <li>3 x intermediate carrier set</li> <li>2 x hinge set</li> <li>1 x half offset hinge set</li> <li>6 x dropbolt</li> </ul>
2L5R	<p>inside WPS, PS RCS ICS ICS WPS, PS</p> <p>outside HS HS HHS</p>	<ul style="list-style-type: none"> <li>2 x pivot set</li> <li>2 x wall pivot set*</li> <li>2 x intermediate carrier set</li> <li>1 x right carrier set</li> <li>2 x hinge set</li> <li>1 x half offset hinge set</li> <li>6 x dropbolt</li> </ul>
8R	<p>inside LCS ICS ICS ICS WPS, PS not accessible from exterior</p> <p>outside HHS HS HS HHS</p>	<ul style="list-style-type: none"> <li>1 x pivot set</li> <li>1 x wall pivot set*</li> <li>3 x intermediate carrier set</li> <li>1 x left carrier set</li> <li>2 x hinge set</li> <li>2 x half offset hinge set</li> <li>8 x dropbolt</li> </ul>

\* Wall Pivot Sets required for doors over 2150mm. Recommended for panels over 1500mm.

# CREATING PRECISION

## Surelock™ Adjustment

Surelock™ is Centor's patented carrier pin locking system which ensures that once door heights are set at the top pivots, intermediate and end carriers, they stay set!

- 1 Components come supplied with a plastic shipping clip installed.
- 2 Insert a flat-bladed screwdriver into the slot and rotate the pin.
- 3 When correct adjustment is reached remove the shipping clip.
- 4 Surelock™ will snap into place when the blade and slot are aligned.
- 5 To readjust pull the blade down to disengage it from the slot, replace the shipping clip and rotate the pin.

Remove shipping clip after final installation adjustment.

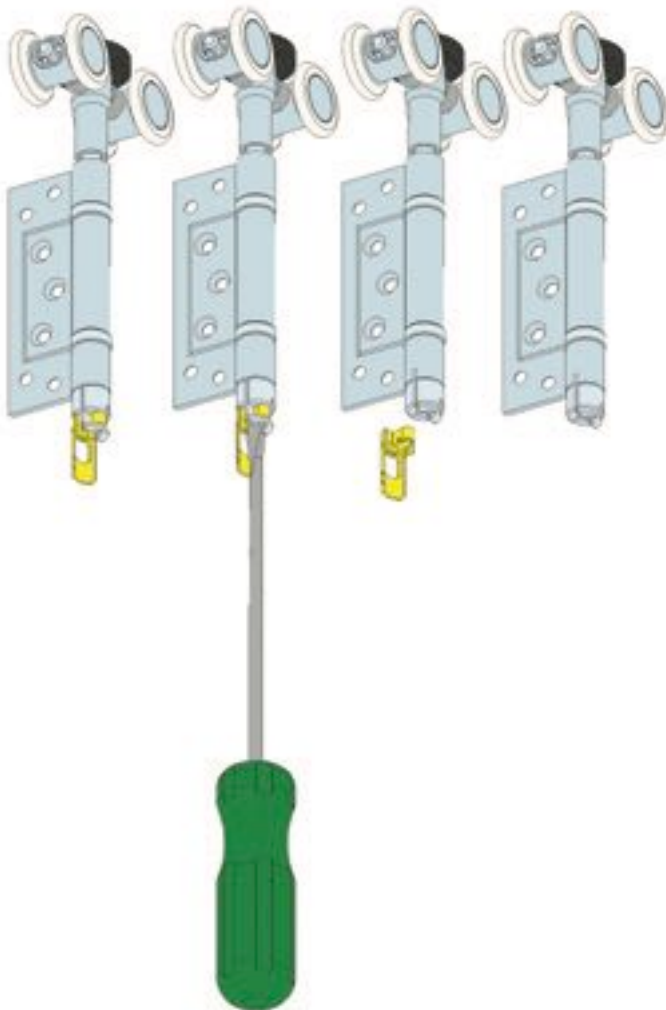

### PIVOT SET Lateral Adjustment

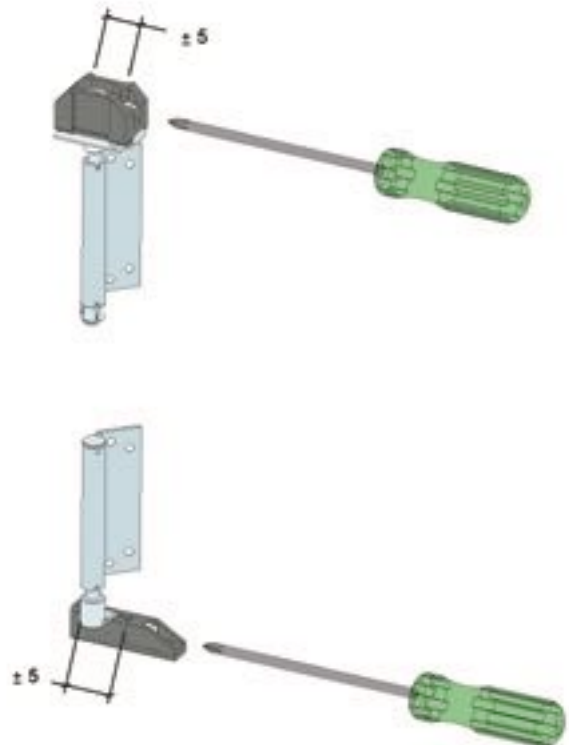

## E3

Centor E3 is a medium-heavy folding door hardware system for door panels to 80 Kg. E3 is suitable for a range of applications from stylish private residences to the most ambitious store front, restaurant or commercial project; anywhere the ability to flexibly manage space to suit lifestyle or business is required. Easily installed E3 hardware can be teamed with standard door panels in timber, aluminium, PVC or fiberglass.



## E3 CLD

Created to address the unique requirements of composite door manufacturers and fabricators, while retaining each of E3's acclaimed features, E3 CLD allows for complete freedom in door set design; inward or outward opening, any odd or even combination of identically-sized panels, all with unparalleled performance from a super-smooth, top-hung system.

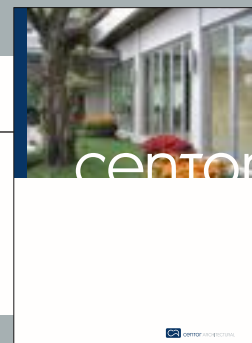

## E4

Centor Architectural's most generously proportioned solution for creating seamless transitions between indoor and outdoor spaces, E4 is heavy-duty folding door hardware for panels to 120 Kg. E4 is suitable for openings in larger residential and commercial applications. Taller, wider door panels, expanses of framed glass; E4 provides the flexibility to manage space for lifestyle or business – on a grand scale.

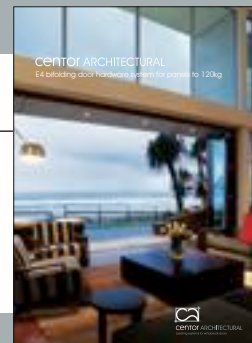

## S1

Centor Screen S1 is a superbly effective solution for any architectural opening up to 3 meters high and 7.4 meters wide. Used alone or in pairs, the system allows for a choice of opening positions with the frames available in custom colors and real wood veneers. Centor's innovative Load Balancing and Tight Technologies are built in each screen assuring mesh tension and effortless fingertip control.

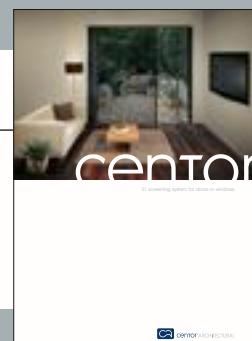



202-300-030-001

Centor Europe Ltd

610 Solar Park  
Highlands Road  
Solihull, B90 4SH, UK  
telephone +44 (0)121 701 2500  
facsimile +44 (0)121 701 2515  
mail@centor.eu  
www.centor.eu