

S6 SCREEN & BLIND SYSTEM



Screen and blind for windows

centor®

*Simply
roll away
when not
needed*



The Centor S6 is an aluminium system for insect screens or blinds up to 1800mm high and 2400mm wide. The vertically retractable, chain-operated system is easily controlled with one hand.

	Frame height (min - max)	Frame width (min - max)
insect screen	300 - 1800mm	500 - 2400mm
sun filter blind	300 - 1800mm	500 - 2400mm
blockout blind	300 - 1800mm	500 - 1800mm



For use with windows

S6 can be paired alongside many window types, including sliding and louvre. The unobtrusive system is simply rolled away when not needed, keeping views to the outside clear and allowing windows to be easily cleaned.

Nest two S6 Screens together to create a duo solution - try insect mesh in one and a blockout shade in the other.

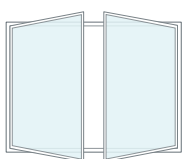

casement

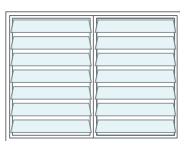

louvre



awning

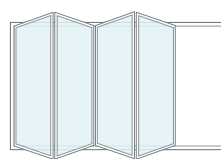

folding

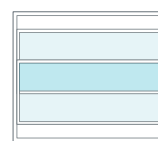

double-hung

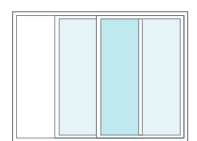

sliding

SCREENING OPTIONS

S6 has the option of an insect screen or blind.

The screen mesh is constructed of long-lasting fibreglass.

Blinds are available in Sun filter, made from fibreglass/PVC or Blockout, made from polyester/cationic polyester.

Screen mesh

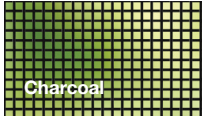

Sun filter blind



Blockout blind – Mercury

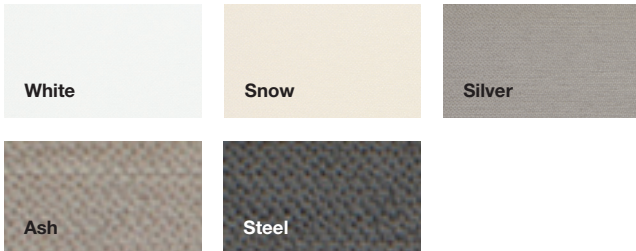

FRAME OPTIONS

S6 is available as standard in natural anodised, while custom colours are available.

The screen rail is finished in a black powder-coat.

Frame

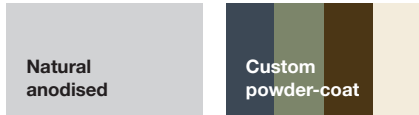

ORDERING S6

S6 is ordered as a kit from Centor in selected heights and widths, ready to be cut to size.

As with all windows and doors handing is expressed when viewed from the outside, so in a left kit the operating cord is on the left when viewed from outside.

NOTE: A LEFT HAND kit when viewed from INSIDE the building would have the cord on the right hand side.

EASY ASSEMBLY AND INSTALLATION

The S6 Screen is designed to be installed on the inside of the opening. Either fully assemble and fit to windows in your factory, or assemble and fit on-site.

WARRANTY

Centor offers a 5-year warranty on its S6 Screen.



S6 PRODUCT DETAILS

Downloadable DXF or DWG files ready for use in your own documentation are a convenient resource for architects and specifiers wishing to use Centor systems.

S6 DXF or DWG files can be downloaded from centor.com

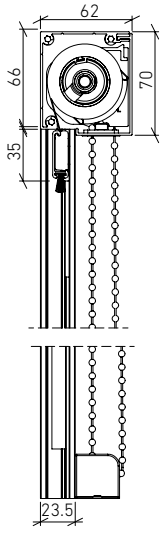

SECTION A-A

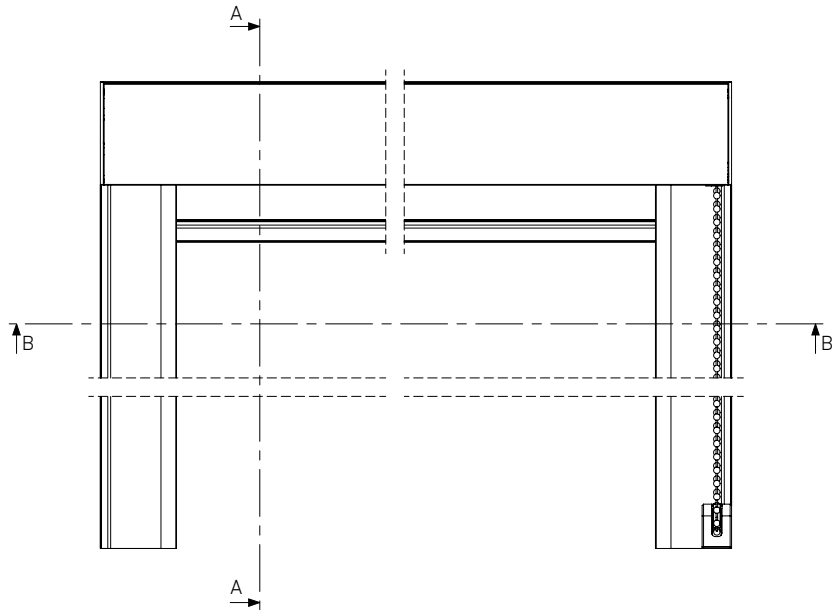
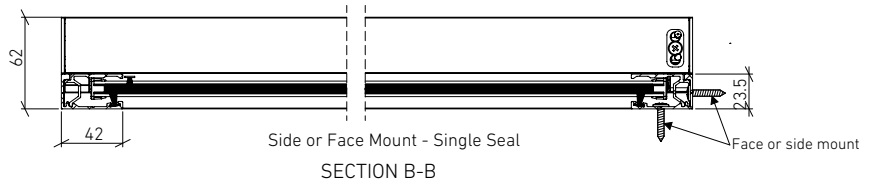
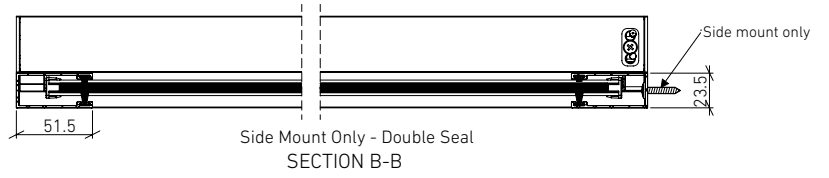

OVERVIEW

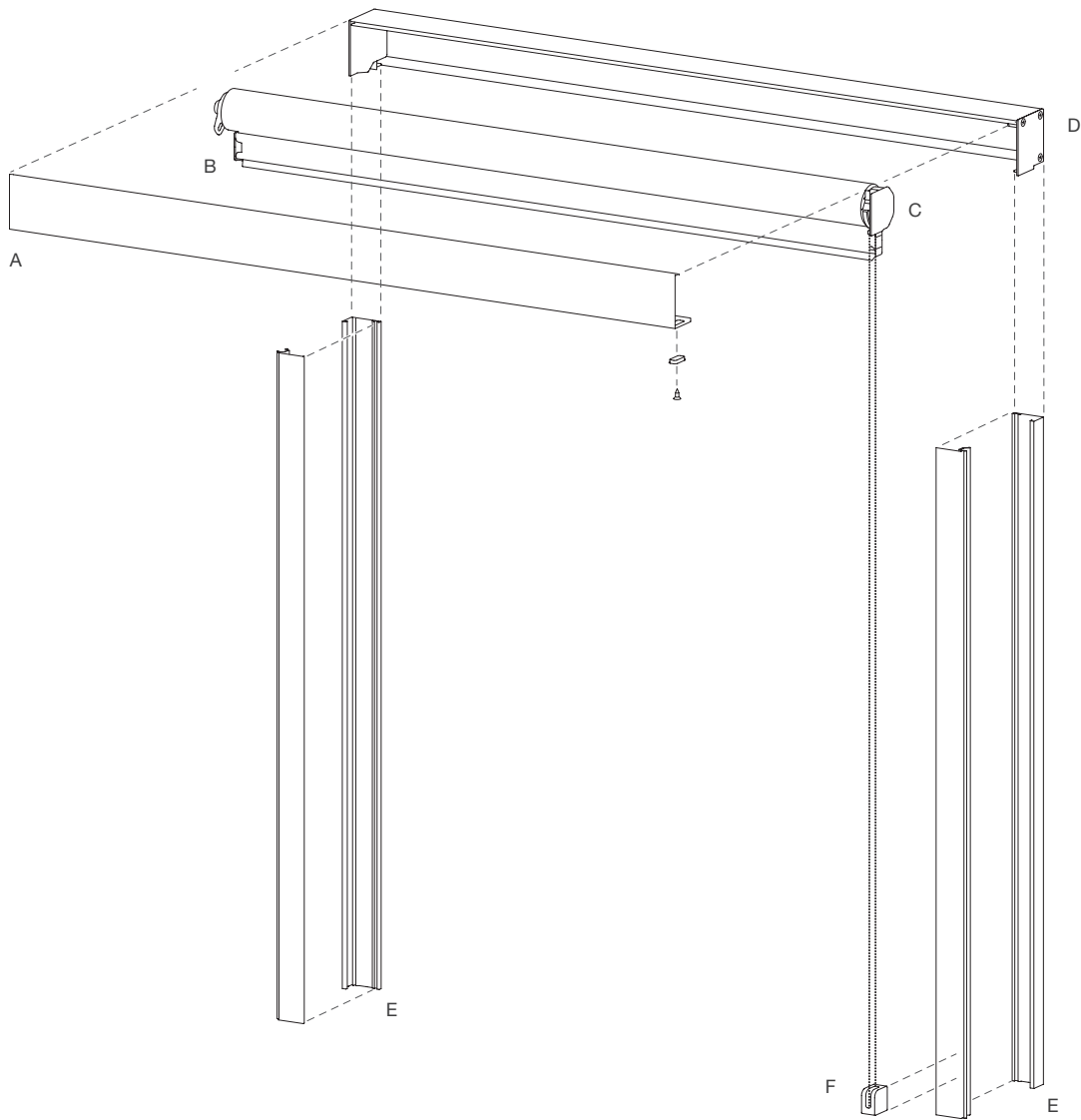

Key

- A Screen cover
- B Screen rail
- C Screen roll
- D Head
- E Screen guide
- F Ball chain

Centor Australia Pty Ltd

1300 CENTOR (1300 236 867)

+61 7 3868 5777

sales@centor.com

centor.com

