

# A9F

internal bifold hardware system

20kg max panel weight

jump-proof four-wheel carriers

side or top-fixed tracking

stainless steel bearings optional

# A9F: BIFOLDING SYSTEM

INTERNAL BIFOLDING HARDWARE SYSTEM FOR PANELS TO 20KG

A9F SPECIFICATIONS	
max panel weight	20kg
max panel height	3000mm
max panel width	620mm
max number of panels	8

Centor A9F is a lightweight alternative where the space-creating benefits of bifold doors are desired, but the weather or acoustic sealing properties of the E Series systems are not required. Perfect teamed with folding doors, shutters or room dividers in residential and light commercial applications, jump-proof 4-wheel carriers with precision bearings mean smooth, reliable performance every time.

## HINGED OR PIVOTED

A9F allows the option of hanging the first panel from the door jamb simply using 'quick-fix' surface-mounted hinges or alternatively equipping the first panel with top and bottom panel pivots. Using the pivots allows all panels to be manufactured in identical dimensions. The hinged method is preferred where security is a requirement. Installation detail and full working calculations for both hinged and pivoted systems are shown in the following pages.

## CARRIERS

Carrier brackets are manufactured in stainless steel with a choice of stainless steel or plated precision bearings. Whisper-quiet nylon tyres complete the package.

## TRACKING AND FLOOR CHANNEL

Top-fixed tracking allows for fastening directly through pre-punched fastening holes, while side-fixed tracking is also an option. Tracking is available in galvanised steel or aluminium. Rebated and surface-mounted floor channel options are available. Both tracking and channel can be provided anodised or powdercoated.

A9F IS THE PERFECT SYSTEM FOR MOBILISING LIGHTWEIGHT DOORS, SHUTTERS AND ROOM DIVIDERS IN INTERNAL RESIDENTIAL AND LIGHT COMMERCIAL APPLICATIONS.

## SPECIFYING A9F

For detailed component selection, including calculating size and number of door panels, specifiers can utilise Doorcalc, Centor's free specification and ordering software. Doorcalc is available from [www.centor.com.au](http://www.centor.com.au)

Architects and Designers can feel comfortable simply specifying "Centor A9F" and leaving detailed component selection to the builder, joiner or fabricator.





## A9F: ARCHITECTURAL DETAIL

Downloadable DXF or DWG files ready for use in your own documentation are a convenient resource for architects and specifiers wishing to use Centor systems.

A9F DXF or DWG files can be downloaded from [www.centor.com.au/au/a9f\\_cad.html](http://www.centor.com.au/au/a9f_cad.html)

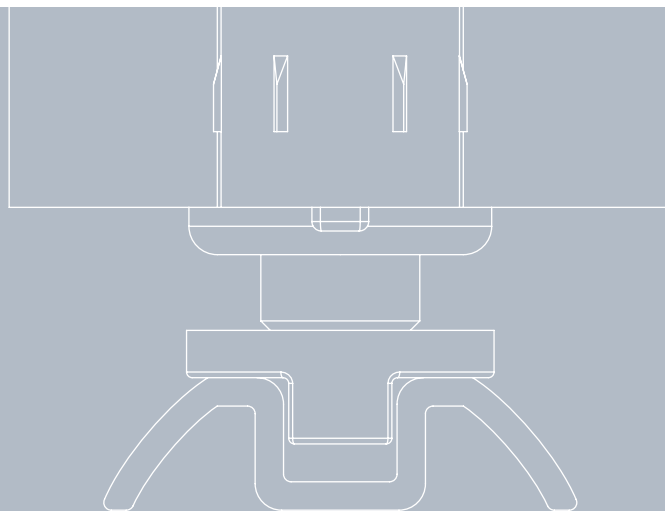

SIDE FIX ALUMINIUM TRACK

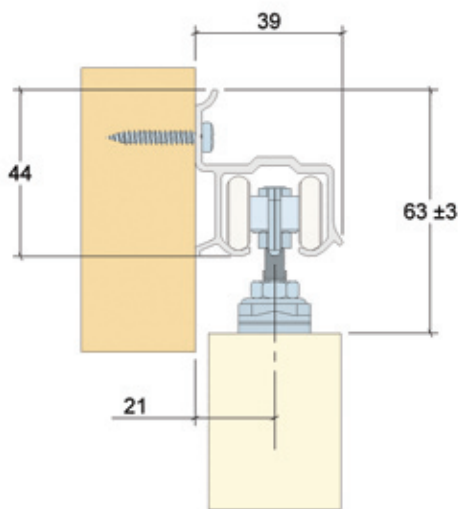

FF-001.DXF

HEAD FIX ALUMINIUM TRACK

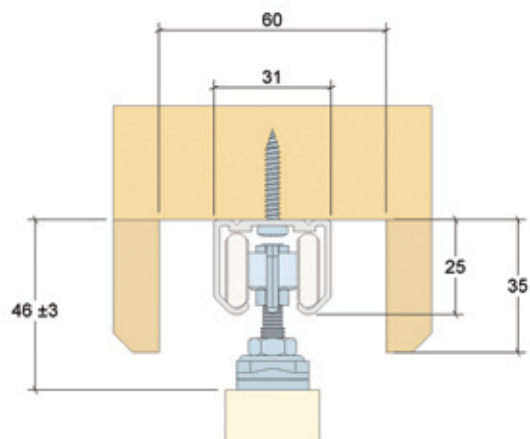

FF-002.DXF

HEAD FIX STEEL TRACK

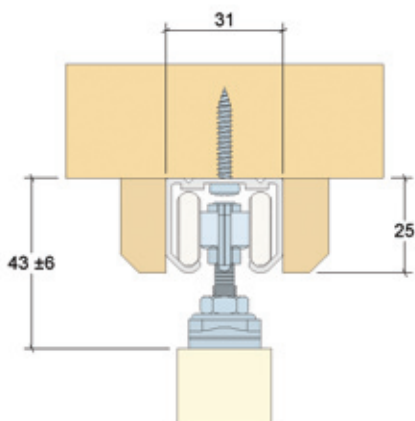

FF-003.DXF

CARRIER



94CCSM / 94CCSS

9TP SPRING LOADED TOP PIVOT

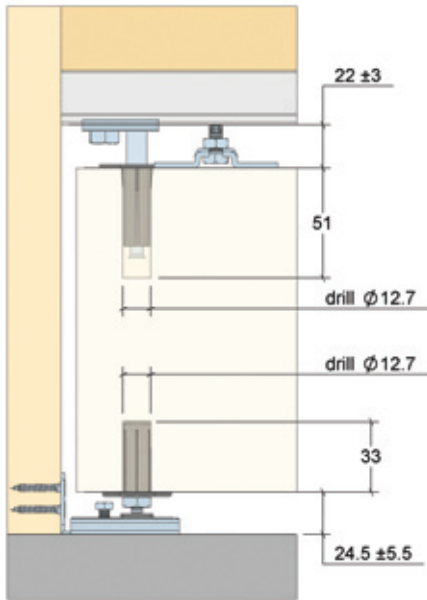

9BLFP Adjustable bottom pivot

FF-004.DXF

9WP WALL MOUNTED BOTTOM PIVOT

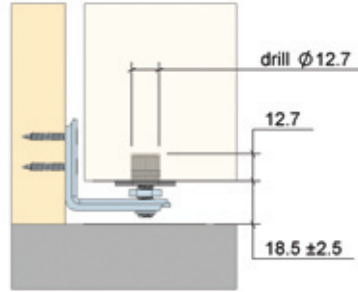

FF-005.DXF

9FP FLOOR MOUNTED BOTTOM PIVOT

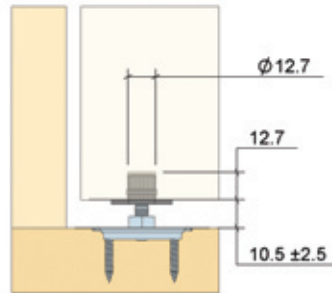

FF-006.DXF

9GC FLOOR CHANNEL ON CONCRETE

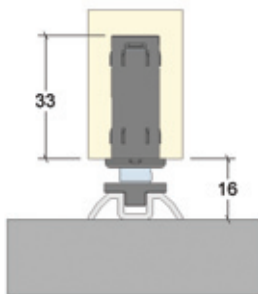

FF-007.DXF

9SLG SPRING LOADED GUIDE



## A9F: COMPONENT SELECTION

A9F is specified with 7 separate component groups. Components are required from each group to build an A9F folding door system except when indicated otherwise.

- 1 **Track** – choose material, surface finish, head-fix or side-fix position and size required to suit opening
- 2 **Carriers** – choose material and number required to suit panel layout
- 3 **Channel\*** – choose fixing type, surface finish and size required to suit opening
- 4 **Guides\*** – choose number required to suit panel layout
- 5 **Jamb Fixings** – choose pivots or hinges, surface finish and number required to suit panel layout
- 6 **Hinges** – choose material and number required to suit panel layout
- 7 **Accessories** – choose items which best suit opening and door panel requirements

\* Floor channel and guides are optional for up to 2 panels in a single direction

### SETS

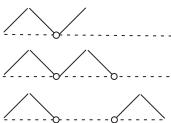
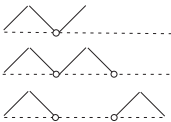
PART	SELECT SET	PRODUCT CODE	PART DESCRIPTION
	head fix aluminium set 1500mm opening	9FF152  2 door folding set 1500mm track	1 x 1500mm track (9TA15) 1 x A9 carriers (94CCSM) 3 x hinges (9H75) 1 x top pivots (9TP) 1 x floor pivots (9BFLP)
	head fix aluminium set 2000mm opening	9FF204  3 and 4 door folding set 2000mm track	1 x 2000mm track (9TA20) 2 x A9 carriers (94CCSM) 6 x hinges (9H75) 2 x top pivots (9TP) 2 x floor pivots (9BFLP) 2x snuggers (9SB or 9SW)
	head fix aluminium set 3000mm opening	9FF304  3 and 4 door set 3000mm track	1 x 3000mm track (9TA30) 2 x A9 carriers (94CCSM) 6 x hinges (9H75) 2 x top pivots (9TP) 2 x floor pivots (9BFLP) 2x snuggers (9SB or 9SW)



### CARRIERS

PART	SELECT WEIGHT	PRODUCT CODE	PART DESCRIPTION
	60kg	94CCSM	4 wheel carrier with stainless brackets and plated precision bearings
	60kg	94CCSS	4 wheel carrier with stainless brackets and stainless precision bearings

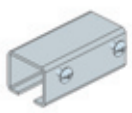

## TRACK

PART	SELECT LENGTH	PRODUCT CODE	PART DESCRIPTION
	2000mm	9TA20	top fix
	3000mm	9TA30	aluminium
	4000mm	9TA40	
	6000mm	9TA60	
	915mm	9TS09	top fix
	1255mm	9TS13	galvanised steel
	2000mm	9TS20	custom lengths for steel track can be roll-formed to order.
	2500mm	9TS25	
	3000mm	9TS30	
	4000mm	9TS40	
	6000mm	9TS60	
	2000mm	9TAS20	side fix
	3000mm	9TAS30	aluminium
	4000mm	9TAS40	
	6000mm	9TAS60	

## ACCESSORIES

PART	PRODUCT NAME	PRODUCT CODE	PART DESCRIPTION
	snubber	9SB 9SW	Pair of brown/white snubbers for aligning centre panels on bi-folding systems where doors part both ways.
	track joining bracket	9JB	Fitted to align steel tracks which are butted together, with carriers traversing the join.
	chipboard adaptor plate	9AP	Adaptor plate used to secure top carrier plate to particle board, chip board or MDF panels.



**OPTIONAL CHANNEL**

PART	CHANNEL AND FINISH	PRODUCT CODE	PART DESCRIPTION
	surface mount natural anodised*	9GC20N	2000mm aluminium surface mount guide channel
		9GC30N	3000mm aluminium surface mount guide channel
		9GC40N	4000mm aluminium surface mount guide channel
		9GC60N	6000mm aluminium surface mount guide channel
	surface mount white powdercoat	9GC20W	2000mm aluminium surface mount guide channel
		9GC30W	3000mm aluminium surface mount guide channel
		9GC40W	4000mm aluminium surface mount guide channel
		9GC60W	6000mm aluminium surface mount guide channel
	surface mount ranch brown p/coat	9GC20B	2000mm aluminium surface mount guide channel
		9GC30B	3000mm aluminium surface mount guide channel
		9GC40B	4000mm aluminium surface mount guide channel
		9GC60B	6000mm aluminium surface mount guide channel
	wood rebate natural anodised*	9FCA2N	2000mm aluminium rebate channel, 10x10mm
		9FCA3N	3000mm aluminium rebate channel, 10x10mm
		9FCA4N	4000mm aluminium rebate channel, 10x10mm
		9FCA6N	6000mm aluminium rebate channel, 10x10mm
	wood rebate white powdercoat	9FCA2W	2000mm aluminium rebate channel, 10x10mm
		9FCA3W	3000mm aluminium rebate channel, 10x10mm
		9FCA4W	4000mm aluminium rebate channel, 10x10mm
		9FCA6W	6000mm aluminium rebate channel, 10x10mm
	wood rebate ranch brown p/coat	9FCA2B	2000mm aluminium rebate channel, 10x10mm
		9FCA3B	3000mm aluminium rebate channel, 10x10mm
		9FCA4B	4000mm aluminium rebate channel, 10x10mm
		9FCA6B	6000mm aluminium rebate channel, 10x10mm
	tile floor	MWT4CA	4000mm, satin anodised

\* Custom powdercoated or anodised available on request

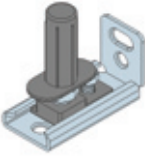
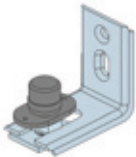
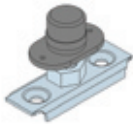

## JAMB FIXING

PART	FIXING METHOD	PRODUCT CODE	DESCRIPTION
	pivoted at jamb	9TP	spring loaded top pivot
	pivoted to jamb	9BFLP	wall and floor fix bottom pivot
	pivoted to jamb	9WP	wall fix bottom pivot
	pivoted at jamb	9FP	floor fix bottom pivot
	hinged to jamb	9H75	non-mortice hinge 75mm brass plated hinge
		9H75SS	non-mortice hinge 75mm stainless steel hinge

## GUIDES

PART	NUMBER OF PANELS	PRODUCT CODE	PART DESCRIPTION
Unguided	2 panels only		no guide needed for two doors in a single direction suits well constructed doors up to 620 x 2440mm
	2 or more panels	9SLG	important: to be used with anodised or powder coated guide channels  spring-loaded nylon guide. use with floor channel drill 12.7 x 33mm hole

# INSTALLATION

## PIVOTED JAMB PANEL

These preparations and sizing calculations apply for folding systems where the jamb panel is pivoted off the jamb (not hinged). Door sizing calculations are shown below. Note that panel widths are always worked on the "whole door" dimension, not including any tongue (if used). It is important that the carriers and guides are mounted square to the edge, faces and top/bottom of stiles. For bi-folding systems (where panels fold apart both ways) the centre panels can be aligned with 9S Snuggers.

### Installation

Drill pivot and guide rebates, hinge matching panels together, separate panels by releasing one side of each hinge, detach carrier with bolt from carrier bracket, fit top spring-loaded plunger and bottom pivot, fit spring loaded guide (if applicable), feed carriers and top pivot clamp into track, fit track (and guide channel if applicable), adjust and secure top pivot clamp, hang panels one at a time from jamb outwards, use carrier adjusting bolt for final adjustment, tighten lock nut.

JAMB CLEARANCES  
PLAIN STILE

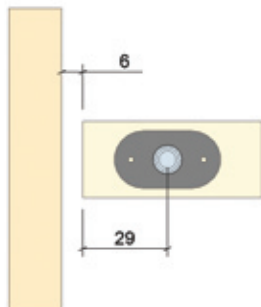

JAMB CLEARANCES  
CHAMFERED STILE

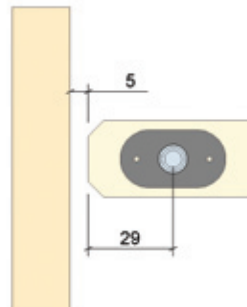

JAMB CLEARANCES  
ROUNDED STILE

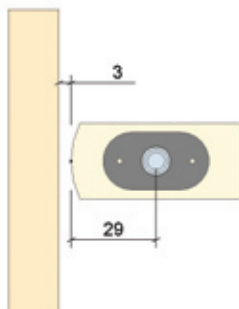

HINGE CLEARANCE = 2MM FOR 9H HINGE

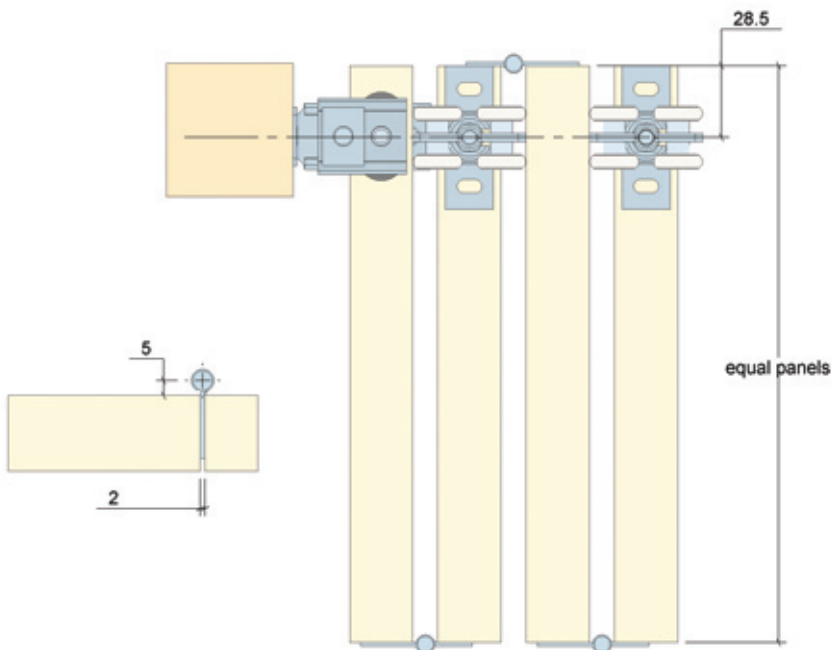

PIVOTED JAMB PANEL

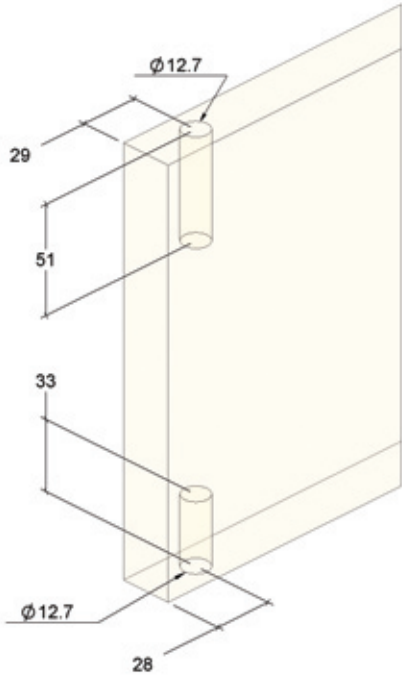

DOOR PANEL SIZING (PIVOTED TO JAMB)

$$\text{exact width of panels} = \frac{\text{opening width} - "C"}{\text{number of panels}}$$

**Clearance for doors folding 1 way**

$$\text{clearance "C"} = \text{jamb clearance} + (\text{number of panels} \times \text{hinge clearance})$$

**Clearance for doors folding 2 way**

$$\text{clearance "C"} = (2 \times \text{jamb clearance}) + ((\text{number of panels} - 1) \times \text{hinge clearance})$$

Select appropriate "jamb clearance" from above illustration based on "jamb panel" stile.

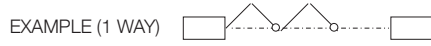

**To use 4 panels in a single direction, across an opening of 1690mm, using "plain" stile on jamb panel with 1mm hinge clearance**

$$\text{clearance} = 6\text{mm} + (4 \times 2\text{mm}) = 14\text{mm}$$

$$\text{panel widths} = \frac{1690 - 14}{4} = 419\text{mm}$$



**To use 3+2 panels in opposing directions, across an opening of 3015mm, using "chamfered" edges on jamb panels and 1mm hinge clearances**

$$\text{clearance} = 2 \times 6\text{mm} + (5 - 1) \times 2 = 20\text{mm}$$

$$\text{panel widths} = \frac{3015 - 20}{5} = 599\text{mm}$$

CARRIER PANEL

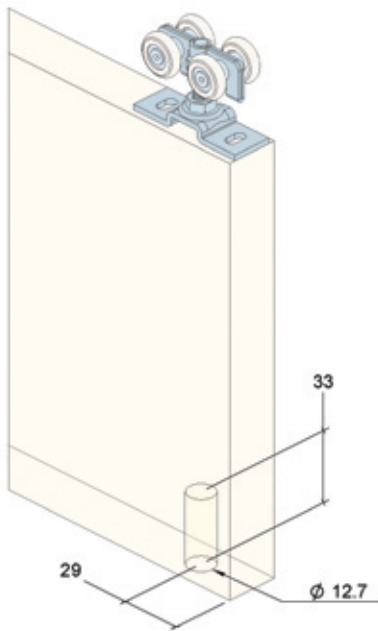

### HINGED JAMB PANEL

These preparations and sizing calculations apply for folding systems where the jamb panel is hinged to the jamb (not pivoted). Door sizing calculations are shown opposite. Note that panel widths are always worked on the "whole door" dimension, not including any tongue (if used). It is important that the carriers and guides are mounted square to the edge, faces and top/bottom of stiles. For bi-folding systems (where panels fold apart both ways) the centre panels can be easily aligned with 9S snuggers.

#### Installation

Drill guide rebates (if applicable), hinge matching panels together, separate panels by releasing one side of each hinge, detach carrier with bolt from carrier bracket, fit carrier bracket, fit spring loaded guide (if applicable), feed carriers into track, fit track and guide channel (if applicable), fit hinges and hang jamb panel, hang other panels one at a time from jamb outwards, adjust carrier for final height adjustment, tighten lock nut on carrier. Fit snuggers (if applicable).

### 94CC CARRIER MOUNTING DETAIL

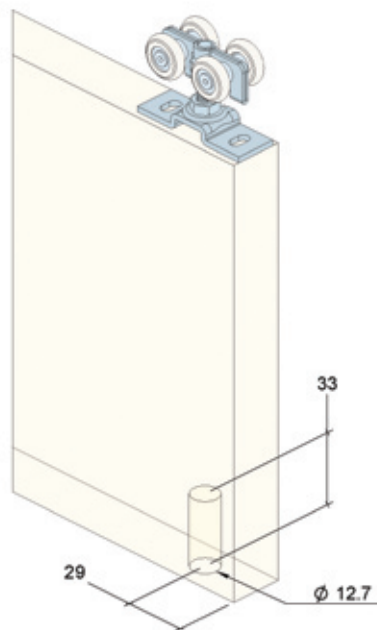

Flush with edge and with centre line of carrier on centre of door thickness.

9SLG Bottom pivot door preparation detail

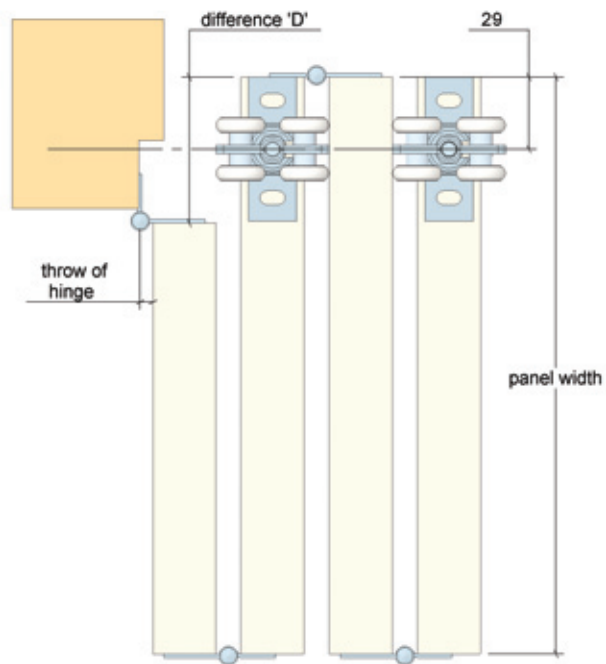

DOOR PANEL SIZING (HINGED TO JAMB)

To avoid error, it is strongly recommended to use Centor's Doorcalc VB™ software to calculate panel widths. Software is available free of charge at [www.centor.com.au](http://www.centor.com.au)

**Difference "D" between full panel size and each jamb panel**

difference "D" = carrier offset (29mm) + 1/2 door thickness + throw of hinge

**Total clearances "C" across opening**

clearances "C" = hinge clearance x (number of panels + 1)

**Exact width of panels for doors folding 1 way**

$$\text{full panel width} = \frac{\text{opening width} + \text{"D"} - \text{"C"}}{\text{number of panels}}$$

**Exact width of panels for doors folding 2 ways**

$$\text{full panel width} = \frac{\text{opening width} + (2 \times \text{"D"}) - \text{"C"}}{\text{number of panels}}$$

**Exact width of all jamb panels**

jamb panel width = full panel width - "D"



To use 4 panels x 38mm thick in a single direction, across an opening of 1695mm, with a throw of hinge of 3mm and hinge clearance of 2mm

$$\text{difference "D"} = 29 + \frac{38}{2} + 3 = 51\text{mm}$$

clearance "C" = (4 + 1) x 2mm = 10mm

$$\text{full panel width} = \frac{1695 + 51 - 10}{4} = 434\text{mm}$$

jamb panel width = 434 - 51 = 383mm

**Hint to check your calculations**

opening = (jamb panel width x qty) + (full panel width x qty) + clearances

$$1695 = (383 \times 4) + (434 \times 3) + 10$$

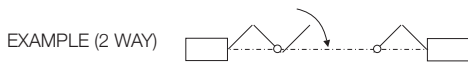

To use 3 + 2 panels x 20mm thick in opposing directions, across an opening of 3023mm, with a throw of hinge of 3mm and hinge clearance of 2mm

$$\text{difference "D"} = 29 + \frac{20}{2} + 3 = 42\text{mm}$$

clearance "C" = (5+1) x 2mm = 12mm

$$\text{full panel width} = \frac{3022 + (42 \times 2) - 12}{5} = 619\text{mm}$$

jamb panel width = 619 - 42 = 577mm

**Hint to check your calculations**

opening = (jamb panel width x qty) + (full panel width x qty) + clearances

$$3022 = (577 \times 3) + (619 \times 2) + 12$$